



maruni

2026-2027

MARUNI COLLECTION

INDEX

		IMAGE	PRODUCTS DATA
PRODUCTS		2 – 59	61 – 175
HIROSHIMA	CHAIRS	3 – 7, 9, 55 – 57, 59	62 – 64, 66
	STOOLS	8	67
	LOUNGE CHAIRS		65
	SOFAS	10, 11, 23, 37	68 – 84
	TABLES		86 – 89
	SHELVES		85
Roundish	CHAIRS	13 – 16	92
	SOFAS	17	96
	TABLES	14	93, 97
Tako	CHAIRS	19 – 21	100
	TABLES	20 – 21	101 – 104
MEGURO	LOUNGE CHAIRS	23	107
Lightwood	CHAIRS	25, 26	110, 111
	STOOLS	27	112 – 116
	SOFAS	28, 29	117
	TABLES		118, 119
	DESKS	26	120
T&O	CHAIRS	31 – 33	124, 125
	STOOLS	34, 35	126 – 128
	TABLES	31 – 33	129 – 135
Fugu	CHAIRS	38, 39	137
	LOUNGE CHAIRS	37	137
	TABLES	38, 39	138, 139
EN	CHAIRS	41 – 43	141
	TABLES	42, 43	141
SHOTO	STOOLS	46	143
	TABLES	10, 11, 28, 29, 37, 45 – 47	144 – 149
Bruno	SOFAS	49 – 51	151
	TABLES	50	152
ASIAN BENCH	STOOL	52	154
	BENCHES	52	154
Botan	BENCHES	53	155
MALTA	TABLES	54, 55	156 – 162
ST	TABLES	56 – 59	164 – 169
Fabric List			172 – 175

HIROSHIMA

NAOTO FUKASAWA



MOUNTAIN RETREAT
Photography: Ema Peter
Architect: Burgers Architecture Inc.
Interior Design: Sophie Burke Design

ARMCHAIR
No.2975-31
oak NL-0 → P.62

HIROSHIMA
by NAOTO FUKASAWA



The Cleveland Foundation
West Entrance

EXIT

Cleveland Clinic
Copyright: Nigel Young / Foster + Partners

ARMCHAIR
No.2976-31 COL
oak NL-0 → P.63
HIROSHIMA
by NAOTO FUKASAWA



CHAIR
 No.2926-20-4169
 oak C-0 → P.64
HIROSHIMA
 by NAOTO FUKASAWA



ARMCHAIR
 No.2986-22 COL
 walnut WB-1 → P.63
HIROSHIMA
 by NAOTO FUKASAWA



Photography: Nacasa & Partners Inc.

STOOL High
 No.2979-82
 oak NK-1 → P.67
HIROSHIMA
 by NAOTO FUKASAWA

STOOL Mid
 No.2978-38, No.2988-61
 oak NL-0, walnut C-0 → P.67
HIROSHIMA
 by NAOTO FUKASAWA



ARMCHAIR STACKABLE
 No.2934-61
 walnut C-0 → P.66
HIROSHIMA
 by NAOTO FUKASAWA



Photography: Nacása & Partners Inc.

WIDE FIVE SEATER WITH CORNER
#4E14
oak NK-1 → P.68 – 84
HIROSHIMA
by NAOTO FUKASAWA

COFFEE TABLE 120 (oval)
No.3E01-34
ash NL-0 → P.144
SHOTO
by CECILIE MANZ

SIDE TABLE 53 (oval)
No.3E11-66
walnut C-0 → P.146
SHOTO
by CECILIE MANZ

Roundish
NAOTO FUKASAWA



PERSOL CAREER
Photography: Nacasa & Partners Inc.
Design: The Design Studio K.K.

ARMCHAIR
No.2387-31-4581・4586
oak NL-0 → P.92

Roundish
by NAOTO FUKASAWA



Photography: Nacása & Partners Inc.

CHAIR
 No.2040-30
 oak NL-0 → P.92
 Roundish
 by NAOTO FUKASAWA

TABLE 240 (oval)
 No.1040-38
 oak NL-0 → P.93
 Roundish
 by NAOTO FUKASAWA



Kvadrat Headquarters
 Photography: Ed Reeve

CHAIR
 No.2061-30-2939
 oak NL-0 → P.92
 Roundish
 by NAOTO FUKASAWA



Photography: Nacasa & Partners Inc.

ARMCHAIR
 No.2385-81, No.2385-31
 oak NK-1, NL-0 → P.92
 Roundish
 by NAOTO FUKASAWA



Yancoal Sydney Workplace
 Photography: Terence Chin
 Interior Design: Hammond Studio

THREE SEATER SOFA
 No.4119-83 COM
 oak NK-1 → P.96
 Roundish
 by NAOTO FUKASAWA

ARM SOFA
 No.4119-81 COM
 oak NK-1 → P.96
 Roundish
 by NAOTO FUKASAWA

Tako
NAOTO FUKASAWA



House in Helsinki
Photography: Paavo Lehtonen

ARMCHAIR
No.2563-61
walnut C-0 → P.100
Tako
by NAOTO FUKASAWA



Photography: Nacása & Partners Inc.

ARMCHAIR
No.2E02-61-5037
walnut C-0 → P.100
Tako
by NAOTO FUKASAWA

ROUND TABLE 150
No.1590-62
walnut C-0 → P.103
Tako
by NAOTO FUKASAWA

MEGURO
NAOTO FUKASAWA



LOUNGE CHAIR
No.4291-61-5022
walnut C-0 → P.107

MEGURO
by NAOTO FUKASAWA

OTTOMAN
No.4E37-65-5022
walnut C-0 → P.107

MEGURO
by NAOTO FUKASAWA

WIDE TWO SEATER SOFA
#3E06
oak NK-1 → P.68 – 84

HIROSHIMA
by NAOTO FUKASAWA

Photography: Nacása & Partners Inc.

Lightwood

JASPER MORRISON



KIRO Hiroshima by THE SHARE HOTELS
Images Courtesy: ReBITA Inc.

ARMCHAIR
No.2512-21-0905
oak C-0 → P.111

Lightwood
by JASPER MORRISON

CUSHION
No.2E16-90-5022
→ P.110

Lightwood
by JASPER MORRISON



Photography: Nacasa & Partners Inc.

CHAIR
No.2E18-30-0E00
oak NL-0 → P.110
Lightwood
by JASPER MORRISON

DESK 120
No.6E05-34
oak NL-0 → P.120
Lightwood
by JASPER MORRISON



Canteen at David Chipperfield Architects, Berlin
Copyright: Ute Zscharnt for David Chipperfield Architects

STOOL High
No.2649-20-0905
maple C-0 → P.116
Lightwood
by JASPER MORRISON

STOOL Low
No.2536-20-0905
maple C-0 → P.114
Lightwood
by JASPER MORRISON



Photography: Nacasa & Partners Inc.

THREE SEATER SOFA
 No.4E23-33-4E20
 ash NL-0 → P.117
 Lightwood
 by JASPER MORRISON

COFFEE TABLE 140
 No.3E05-36
 ash NL-0 → P.145
 SHOTO
 by CECILIE MANZ



Photography: Nacasa & Partners Inc.

COFFEE TABLE 125 (oval)
 No.3E01-35
 ash NL-0 → P.144
 SHOTO
 by CECILIE MANZ

COFFEE TABLE 140
 No.3E05-36
 ash NL-0 → P.145
 SHOTO
 by CECILIE MANZ

COFFEE TABLE 85
 No.: —
 ash NL-0 → P.145
 SHOTO
 by CECILIE MANZ
 The stone top is bespoke.

THREE SEATER SOFA
 No.4E23-33-4E17
 ash NL-0 → P.117
 Lightwood
 by JASPER MORRISON

T&O
JASPER MORRISON



ROUND TABLE 90
No.1632-93-0906
ash NL-0 silver → P.130
T&O
by JASPER MORRISON

T1 CHAIR STACKABLE
No.2E06-36
ash NL-0 silver → P.124
T&O
by JASPER MORRISON

Photography: Nacása & Partners Inc.



Tsuchiya Kaban CO., LTD.
Photography: Nacása & Partners Inc.

T1 CHAIR
No.2670-22
maple C-0 black → P.124
T&O
by JASPER MORRISON

ROUND TABLE 90
No.1572-92-0902
maple C-0 black → P.130
T&O
by JASPER MORRISON



Photography: Nacása & Partners Inc.

O2 STOOL Mid
 No.2852-86
 maple NK-1 silver → P.127
 T&O
 by JASPER MORRISON

T3 BAR STOOL High
 No.2677-86
 maple NK-1 silver → P.126
 T&O
 by JASPER MORRISON



O3 STOOL High
 No.2857-22
 maple C-0 black → P.128
 T&O
 by JASPER MORRISON

Fugu
JASPER MORRISON



WIDE TWO SEATER SOFA
#4E14
oak NK-1 → P.68 – 84

HIROSHIMA
by NAOTO FUKASAWA

COFFEE TABLE 120 (oval)
No.3E02-34
oak NL-0 → P.144

SHOTO
by CECILIE MANZ

LOUNGE CHAIR (with armrests)
No.4416-31
oak NL-0 → P.137

Fugu
by JASPER MORRISON

Photography: Nacása & Partners Inc.



Photography: Nacása & Partners Inc.

TABLE 220 (oval)
No.1E00-37
oak NL-0 → P.138

Fugu
by JASPER MORRISON

CHAIR
No.2416-30
oak NL-0 → P.137

Fugu
by JASPER MORRISON

ARMCHAIR
No.2416-31
oak NL-0 → P.137

Fugu
by JASPER MORRISON

EN
CECILIE MANZ



Photography: Nacasa & Partners Inc.

CHAIR
No.2E11-20-2E07
maple C-0 → P.141
EN
by CECILIE MANZ



ROUND TABLE 140
No.1E06-23
maple C-0 → P.141
EN
by CECILIE MANZ

CHAIR
No.2E11-20-2E07 • 3E01 • 3E02 • 5006 • COM
maple C-0 → P.141
EN
by CECILIE MANZ

SHOTO
CECILIE MANZ



TRAY TABLE 57 (oval)
No.3E39-32
ash NL-0 → P.145

SHOTO
by CECILIE MANZ

COFFEE TABLE 105 (oval)
No.3E01-33
ash NL-0 → P.144

SHOTO
by CECILIE MANZ

COFFEE TABLE 125 (oval)
No.3E01-35
ash NL-0 → P.144

SHOTO
by CECILIE MANZ

Photography: Nacása & Partners Inc.



STOOL Mid
No.2E70-36
ash NL-0 → P.143
SHOTO
by CECILIE MANZ

BAR TABLE 76 Mid (oval)
No.1E53-36
ash NL-0 → P.149
SHOTO
by CECILIE MANZ



SIDE TABLE 53,70,76 (oval)
ash NL-0 → P.146
SHOTO
by CECILIE MANZ

LOBBY TABLE 53,70,76 (oval)
ash NL-0 → P.147
SHOTO
by CECILIE MANZ

TABLE 53,70,76 (oval)
ash NL-0 → P.148
SHOTO
by CECILIE MANZ

Bruno

JASPER MORRISON

ASIAN BENCH

NAOTO FUKASAWA

Botan

JASPER MORRISON

MALTA

NAOTO FUKASAWA

ST

NAOTO FUKASAWA



THREE SEATER SOFA
No.4506-33-2939
oak NL-0 → P.151
Bruno
by JASPER MORRISON



Photography: Nacása & Partners Inc.

COFFEE TABLE 135
No.3547-32
ash NL-0 → P.152
Bruno
by JASPER MORRISON

WIDE TWO SEATER SOFA
No.4517-34 COM
ash NL-0 → P.151
Bruno
by JASPER MORRISON

ARM SOFA
No.4517-31 COM
ash NL-0 → P.151
Bruno
by JASPER MORRISON



Photography: Nacasa & Partners Inc.

STOOL
No.2017-95
oak MR-1 → P.154

ASIAN BENCH
by NAOTO FUKASAWA

BENCH 165
No.2014-94
oak MR-1 → P.154

ASIAN BENCH
by NAOTO FUKASAWA

BENCH 240
No.2014-98
oak MR-1 → P.154

ASIAN BENCH
by NAOTO FUKASAWA



COLLECTION
DISPLAYS
BETWEEN OBJECT
AND ARCHITECTURE

New Tate Modern
Photography: Nicola Tree

BENCH 300
No.: —
oak NL-0 → P.155

Botan
by JASPER MORRISON

The bench in the image is
a bespoke size W3,000 (mm)
for the New Tate Modern.



TABLE 240 [Steel leg]
 No.1887-93-2470
 oak NL-0 → P.161
MALTA
 by NAOTO FUKASAWA



TABLE 640
 No.:—
 oak NL-0 → P.156

MALTA
 by NAOTO FUKASAWA

The table in the image is a bespoke size 6,400 (mm).

ARMCHAIR
 No.2975-31
 oak NL-0 → P.62

HIROSHIMA
 by NAOTO FUKASAWA

Photography: Nacasa & Partners Inc.



Photography: Nacása & Partners Inc.

TABLE 350

No.: —
walnut C-0 → P.164

ST
by NAOTO FUKASAWA

The table in the image is a bespoke size 3,500 (mm).

ARMCHAIR

No.2986-61-5037
walnut C-0 → P.63

HIROSHIMA
by NAOTO FUKASAWA



TABLE 280 (ceramic top)
 No.1E18-69
 walnut C-0 → P.169
 ST
 by NAOTO FUKASAWA



















Photography: Nacasa & Partners Inc.

TABLE 240 (ceramic top)
 No.1E18-68
 walnut C-0 → P.168
 ST
 by NAOTO FUKASAWA

ARMCHAIR
 No.2986-61-5191
 walnut C-0 → P.63
HIROSHIMA
 by NAOTO FUKASAWA

ARMCHAIR
 No.2985-61
 walnut C-0 → P.62
HIROSHIMA
 by NAOTO FUKASAWA

PRODUCTS DATA



Chair	beech	 whitish (NL-0)	 matte black (EC-1)	 matte white (EA-1)	
	ash	 whitish (NL-0)	 dark brown (WS-1)	 natural black (NK-1)	
	oak	 bold whitish (NQ-0)	 bold black (BNK-1)	 bold charcoal (NU-0)	 bold gray (BOG-0)
		 clear (C-0)	 whitish (NL-0)	 natural black (NK-1)	 light gray (OG-0)
		 clear (NB-1/Oil)			
walnut	 clear (C-0)	 light brown (WB-1)			

ARMCHAIR Low (wooden seat)
W560×D530×H765×SH425
arm height : 655 (mm)
[W22.1×D20.9×H30.2×SH16.8
arm height : 25.8 (in)]



ARMCHAIR High (wooden seat)
W560×D530×H790×SH450
arm height : 680 (mm)
[W22.1×D20.9×H31.2×SH17.8
arm height : 26.8 (in)]

beech	No.2955-31	No.2E37-81	No.2E37-61	
ash	No.2E14-31	No.2E14-51	No.2E14-81	
oak	No.2E38-F1	No.2E38-81	No.2E38-K1	No.2E38-71
	No.2975-21	No.2975-31	No.2975-81	No.2975-71
	No.2975-41			
walnut	No.2985-61	No.2985-21		
beech	No.2955-32	No.2E37-82	No.2E37-62	
ash	No.2E14-32	No.2E14-52	No.2E14-82	
oak	No.2E38-F2	No.2E38-82	No.2E38-K2	No.2E38-72
	No.2975-22	No.2975-32	No.2975-82	No.2975-72
	No.2975-42			
walnut	No.2985-62	No.2985-22		

Chair	beech	 whitish (NL-0)	 matte black (EC-1)	 matte white (EA-1)	
	ash	 whitish (NL-0)	 dark brown (WS-1)	 natural black (NK-1)	
	oak	 bold whitish (NQ-0)	 bold black (BNK-1)	 bold charcoal (NU-0)	 bold gray (BOG-0)
		 clear (C-0)	 whitish (NL-0)	 natural black (NK-1)	 light gray (OG-0)
		 clear (NB-1/Oil)			
walnut	 clear (C-0)	 light brown (WB-1)			

ARMCHAIR Low (cushioned)
W560×D530×H765×SH430
arm height : 655 (mm)
[W22.1×D20.9×H30.2×SH17.0
arm height : 25.8 (in)]















ARMCHAIR High (cushioned)
W560×D530×H790×SH455
arm height : 680 (mm)
[W22.1×D20.9×H31.2×SH18.0
arm height : 26.8 (in)]

beech	No.2956-31	No.2E39-81	No.2E39-61	
ash	No.2E15-31	No.2E15-51	No.2E15-81	
oak	No.2E40-F1	No.2E40-81	No.2E40-K1	No.2E40-71
	No.2976-21	No.2976-31	No.2976-81	No.2976-71
	No.2976-41			
walnut	No.2986-61	No.2986-21		
beech	No.2956-32	No.2E39-82	No.2E39-62	
ash	No.2E15-32	No.2E15-52	No.2E15-82	
oak	No.2E40-F2	No.2E40-82	No.2E40-K2	No.2E40-72
	No.2976-22	No.2976-32	No.2976-82	No.2976-72
	No.2976-42			
walnut	No.2986-62	No.2986-22		

seat cover for ARMCHAIR

No.2956-90 Available only in fabrics.

Chair	beech	 whitish (NL-0)	 matte black (EC-1)	 matte white (EA-1)	
	oak	 bold whitish (NQ-0)	 bold black (BNK-1)	 bold charcoal (NU-0)	 bold gray (BOG-0)
		 clear (C-0)	 whitish (NL-0)	 natural black (NK-1)	 light gray (OG-0)
walnut	 clear (C-0)	 light brown (WB-1)			

WIDE ARMCHAIR Low
W678×D614×H768×SH430
arm height : 655 (mm)
[W26.7×D24.2×H30.3×SH17.0
arm height : 25.8 (in)]

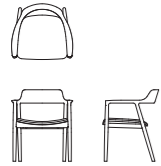

WIDE ARMCHAIR High
W678×D614×H793×SH455
arm height : 680 (mm)
[W26.7×D24.2×H31.3×SH18.0
arm height : 26.8 (in)]

seat cover for WIDE ARMCHAIR No.4059-90 Available only in fabrics.

CHAIR
W390×D480×H790×SH450 (mm)
[W15.4×D18.9×H31.2×SH17.8 (in)]

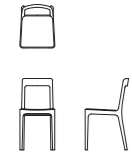

seat cover for CHAIR No.2906-90 Available only in fabrics.

FOLDING CHAIR
W498×D552×H816×SH450 (mm)
[W19.7×D21.8×H32.2×SH17.8 (in)]
Veneered Plywood

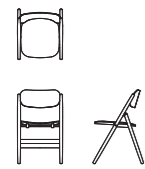

beech	No.2E08-31	No.2E49-81	No.2E49-61	
oak	No.2E50-F1	No.2E50-81	No.2E50-K1	No.2E50-71
	No.2E09-21	No.2E09-31	No.2E09-81	No.2E09-71
walnut	No.2E10-61	No.2E10-21		
beech	No.2E08-32	No.2E49-82	No.2E49-62	
oak	No.2E50-F2	No.2E50-82	No.2E50-K2	No.2E50-72
	No.2E09-22	No.2E09-32	No.2E09-82	No.2E09-72
walnut	No.2E10-62	No.2E10-22		

Chair • Ottoman	beech	 whitish (NL-0)	 matte black (EC-1)	 matte white (EA-1)	
	oak	 bold whitish (NQ-0)	 bold black (BNK-1)	 bold charcoal (NU-0)	 bold gray (BOG-0)
		 clear (C-0)	 whitish (NL-0)	 natural black (NK-1)	 light gray (OG-0)
walnut	 clear (C-0)	 light brown (WB-1)			

LOUNGE CHAIR
W678×D640×H684×SH375
arm height : 595 (mm)
[W26.7×D25.2×H27.0×SH14.8
arm height : 23.5 (in)]



seat cover for LOUNGE CHAIR No.4059-90 Available only in fabrics.



OTTOMAN
W575×D395×H405×SH375 (mm)
[W22.7×D15.6×H16.0×SH14.8 (in)]



seat cover for OTTOMAN No.4064-90 Available only in fabrics.

beech	No.4059-31	No.4E26-81	No.4E26-61	
oak	No.4E27-F1	No.4E27-81	No.4E27-K1	No.4E27-71
	No.4061-21	No.4061-31	No.4061-81	No.4061-71
walnut	No.4080-61	No.4080-21		
beech	No.4064-35	No.4E28-85	No.4E28-65	
oak	No.4E29-F5	No.4E29-85	No.4E29-K5	No.4E29-75
	No.4066-25	No.4066-35	No.4066-85	No.4066-75
walnut	No.4085-65	No.4085-25		

Chair

beech	 whitish (NL-0)	 matte black (EC-1)	 matte white (EA-1)	
oak	 bold whitish (NQ-0)	 bold black (BNK-1)	 bold charcoal (NU-0)	 bold gray (BOG-0)
	 clear (C-0)	 whitish (NL-0)	 natural black (NK-1)	 light gray (OG-0)
walnut	 clear (C-0)	 light brown (WB-1)		

ARMCHAIR STACKABLE (wooden seat) Chrome plated stainless steel base	beech	No.2904-31	No.2E51-81	No.2E51-61	
	oak	No.2E52-F1	No.2E52-81	No.2E52-K1	No.2E52-71
		No.2924-21	No.2924-31	No.2924-81	No.2924-71
walnut	No.2934-61	No.2934-21			
ARMCHAIR STACKABLE (wooden seat) Brushed stainless steel base	beech	No.2904-38	No.2E51-88	No.2E51-68	
	oak	No.2E52-F8	No.2E52-88	No.2E52-K8	No.2E52-78
		No.2924-28	No.2924-38	No.2924-88	No.2924-78
walnut	No.2934-68	No.2934-28			
ARMCHAIR STACKABLE (wooden seat) Black powder coated stainless-steel base	beech	No.2904-32	No.2E51-82	No.2E51-62	
	oak	No.2E52-F2	No.2E52-82	No.2E52-K2	No.2E52-72
		No.2924-22	No.2924-32	No.2924-82	No.2924-72
walnut	No.2934-62	No.2934-22			
ARMCHAIR STACKABLE (cushioned) Chrome plated stainless steel base	beech	No.2905-31	No.2E53-81	No.2E53-61	
	oak	No.2E54-F1	No.2E54-81	No.2E54-K1	No.2E54-71
		No.2925-21	No.2925-31	No.2925-81	No.2925-71
walnut	No.2935-61	No.2935-21			
ARMCHAIR STACKABLE (cushioned) Brushed stainless steel base	beech	No.2905-38	No.2E53-88	No.2E53-68	
	oak	No.2E54-F8	No.2E54-88	No.2E54-K8	No.2E54-78
		No.2925-28	No.2925-38	No.2925-88	No.2925-78
walnut	No.2935-68	No.2935-28			
ARMCHAIR STACKABLE (cushioned) Black powder coated stainless-steel base	beech	No.2905-32	No.2E53-82	No.2E53-62	
	oak	No.2E54-F2	No.2E54-82	No.2E54-K2	No.2E54-72
		No.2925-22	No.2925-32	No.2925-82	No.2925-72
walnut	No.2935-62	No.2935-22			



W535×D515×H738×SH449
arm height : 677 (mm)
[W21.1×D20.3×H29.1×SH17.7
arm height : 26.7 (in)]



876 (mm)
34.5 (in)
max.4



W535×D515×H738×SH452
arm height : 677 (mm)
[W21.1×D20.3×H29.1×SH17.8
arm height : 26.7 (in)]







900 (mm)
35.5 (in)
max.4

seat cover for ARMCHAIR STACKABLE

No.2905-90 Available only in fabrics.

Stool

beech	 whitish (NL-0)	 matte black (EC-1)	 matte white (EA-1)	
oak	 bold whitish (NQ-0)	 bold black (BNK-1)	 bold charcoal (NU-0)	 bold gray (BOG-0)
	 clear (C-0)	 whitish (NL-0)	 natural black (NK-1)	 light gray (OG-0)
walnut	 clear (C-0)	 light brown (WB-1)		

STOOL Mid Chrome plated stainless steel base	beech	No.2958-31	No.2E55-81	No.2E55-61	
	oak	No.2E56-F1	No.2E56-81	No.2E56-K1	No.2E56-71
		No.2978-21	No.2978-31	No.2978-81	No.2978-71
walnut	No.2988-61	No.2988-21			
STOOL Mid Brushed stainless steel base	beech	No.2958-38	No.2E55-88	No.2E55-68	
	oak	No.2E56-F8	No.2E56-88	No.2E56-K8	No.2E56-78
		No.2978-28	No.2978-38	No.2978-88	No.2978-78
walnut	No.2988-68	No.2988-28			
STOOL Mid Black powder coated stainless-steel base	beech	No.2958-32	No.2E55-82	No.2E55-62	
	oak	No.2E56-F2	No.2E56-82	No.2E56-K2	No.2E56-72
		No.2978-22	No.2978-32	No.2978-82	No.2978-72
walnut	No.2988-62	No.2988-22			
STOOL High Chrome plated stainless steel base	beech	No.2959-31	No.2E57-81	No.2E57-61	
	oak	No.2E58-F1	No.2E58-81	No.2E58-K1	No.2E58-71
		No.2979-21	No.2979-31	No.2979-81	No.2979-71
walnut	No.2989-61	No.2989-21			
STOOL High Brushed stainless steel base	beech	No.2959-38	No.2E57-88	No.2E57-68	
	oak	No.2E58-F8	No.2E58-88	No.2E58-K8	No.2E58-78
		No.2979-28	No.2979-38	No.2979-88	No.2979-78
walnut	No.2989-68	No.2989-28			
STOOL High Black powder coated stainless-steel base	beech	No.2959-32	No.2E57-82	No.2E57-62	
	oak	No.2E58-F2	No.2E58-82	No.2E58-K2	No.2E58-72
		No.2979-22	No.2979-32	No.2979-82	No.2979-72
walnut	No.2989-62	No.2989-22			



W409×D403×H762
×SH642 (mm)
[W16.2×D15.9×H30.0
×SH25.3 (in)]



W458×D421×H902
×SH782 (mm)
[W18.1×D16.6×H35.6
×SH30.8 (in)]

Sofa

Configurations

WIDE TWO SEATER SOFA

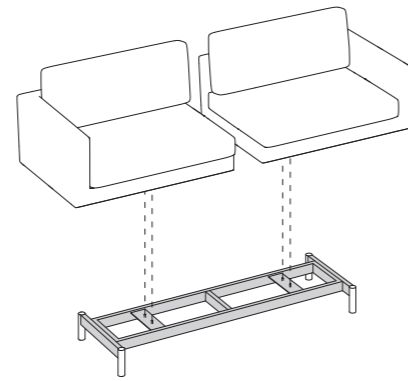
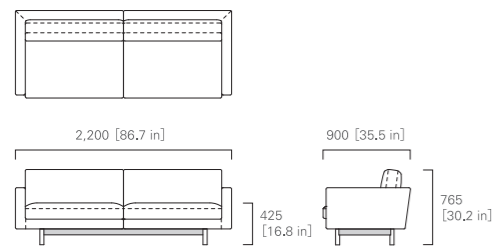

- WIDE ONE ARM SOFA Right x1
- WIDE ONE ARM SOFA Left x1
- LEGGED FRAME FOR WIDE TWO SEATER x1

WIDE THREE SEATER SOFA

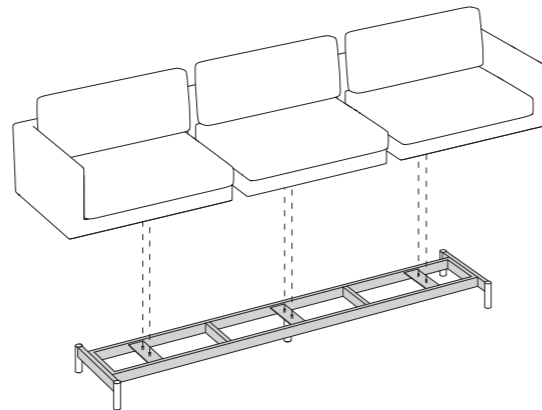
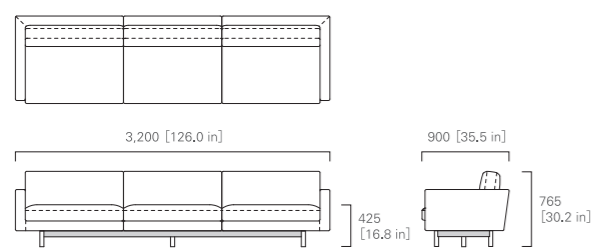

- WIDE ONE ARM SOFA Right x1
- WIDE ARMLESS SOFA x1
- WIDE ONE ARM SOFA Left x1
- LEGGED FRAME FOR WIDE THREE SEATER x1

Sofa

Configurations

WIDE THREE SEATER WITH ARMLESS ANGLED SOFA

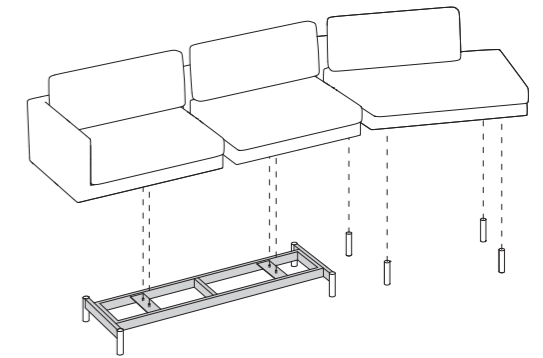
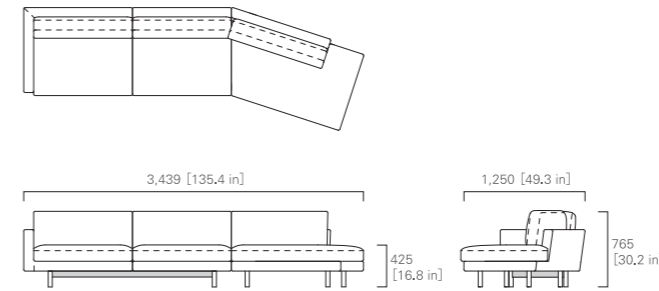

- WIDE ONE ARM SOFA Right x1
- WIDE ARMLESS SOFA x1
- ARMLESS ANGLED SOFA Left x1
- LEGGED FRAME FOR WIDE TWO SEATER x1
- SCREW-TYPE LEG (set of 4) x1

WIDE THREE SEATER WITH ONE ARM ANGLED SOFA

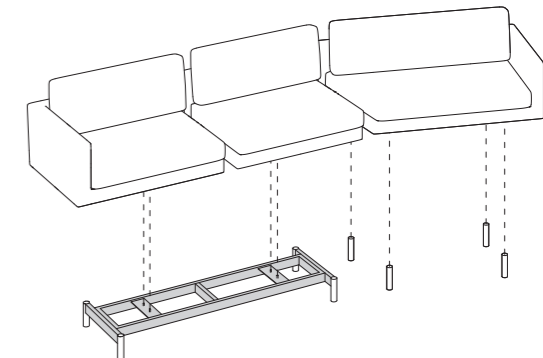
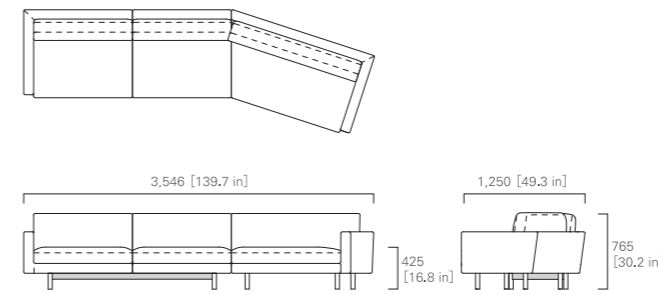

- WIDE ONE ARM SOFA Right x1
- WIDE ARMLESS SOFA x1
- ONE ARM ANGLED SOFA Left x1
- LEGGED FRAME FOR WIDE TWO SEATER x1
- SCREW-TYPE LEG (set of 4) x1

Sofa

Configurations

WIDE TWO SEATER WITH CHAISE LONGUE

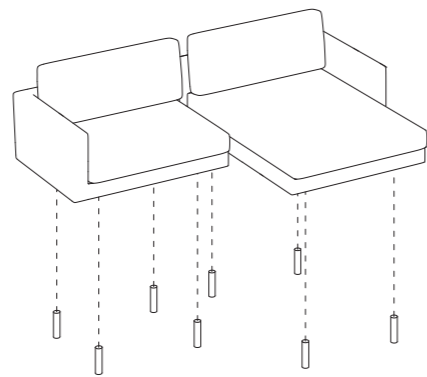
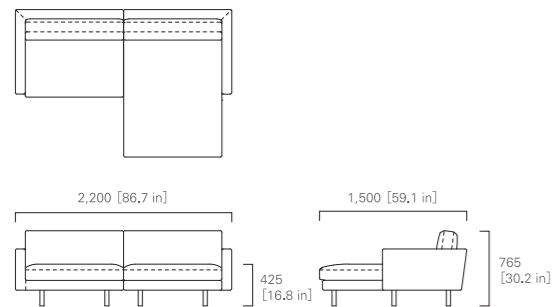

WIDE ONE ARM SOFA Right x1
WIDE CHAISE LONGUE 150 Left x1

SCREW-TYPE LEG (set of 4) x2

WIDE THREE SEATER WITH CHAISE LONGUE

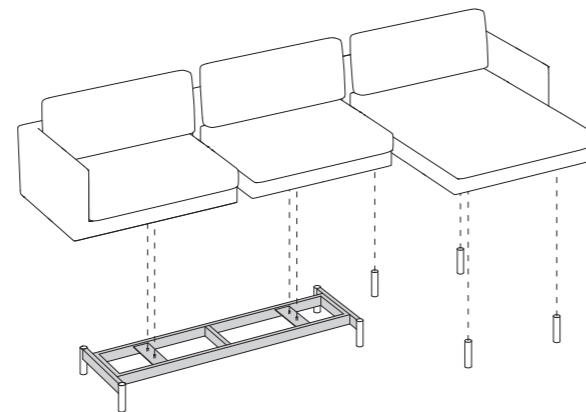
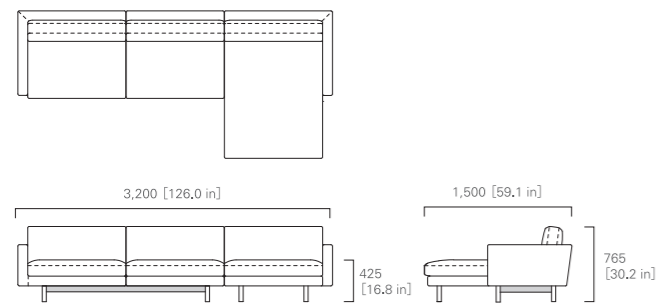

WIDE ONE ARM SOFA Right x1
WIDE ARMLESS SOFA x1
WIDE CHAISE LONGUE 150 Left x1

LEGGED FRAME FOR WIDE TWO SEATER x1
SCREW-TYPE LEG (set of 4) x1

Sofa

Configurations

WIDE FOUR SEATER WITH CORNER

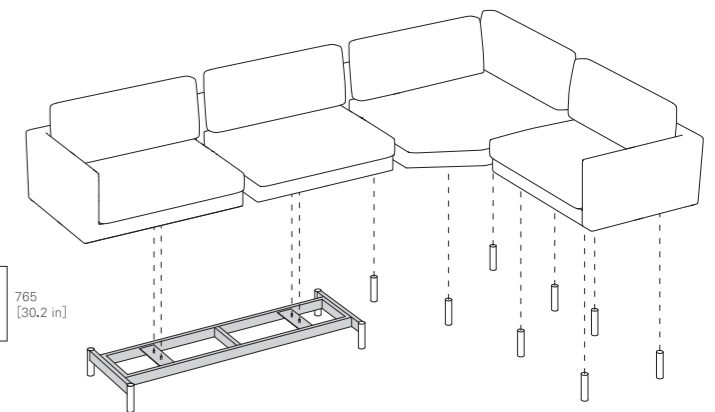
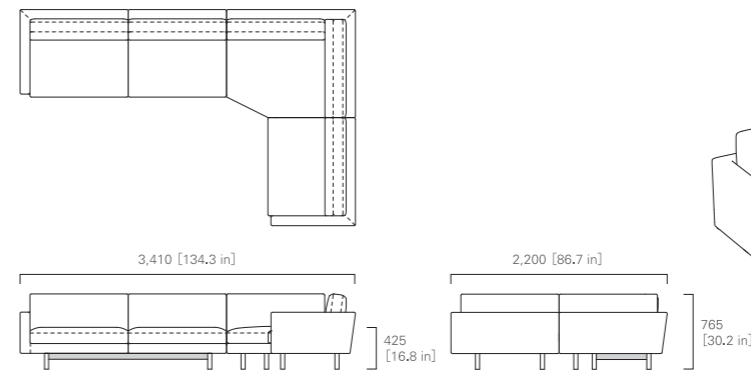

WIDE ONE ARM SOFA Right x1
WIDE ARMLESS SOFA x1
WIDE CORNER SOFA Left x1
WIDE ONE ARM SOFA Left x1

LEGGED FRAME FOR WIDE TWO SEATER x1
SCREW-TYPE LEG (set of 4) x2

WIDE SIX SEATER WITH CORNER AND OTTOMAN

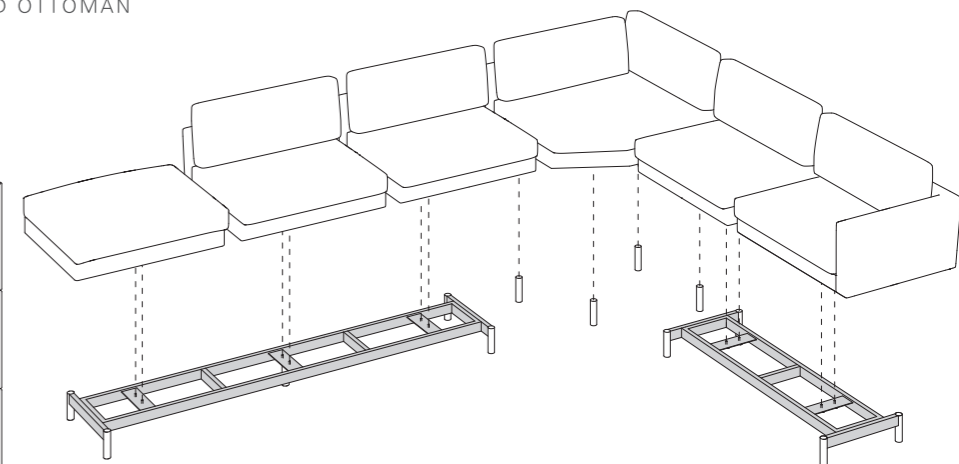
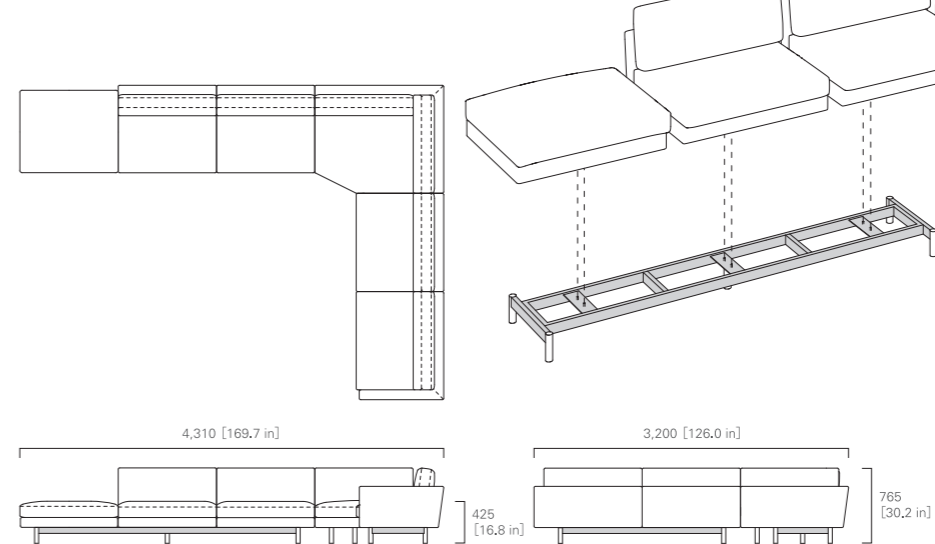

WIDE OTTOMAN 100 x1
WIDE ARMLESS SOFA x3
WIDE CORNER SOFA Left x1
WIDE ONE ARM SOFA Left x1

LEGGED FRAME FOR WIDE THREE SEATER x1
SCREW-TYPE LEG (set of 4) x1
LEGGED FRAME FOR WIDE TWO SEATER x1

Sofa

1P UNIT

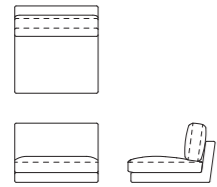

ARMLESS SOFA
W850×D900×H605 (mm)
[W33.5×D35.5×H23.9 (in)]

No.4E11-10

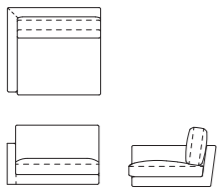

ONE ARM SOFA Right
W950×D900×H605 (mm)
[W37.5×D35.5×H23.9 (in)]

No.4E11-14

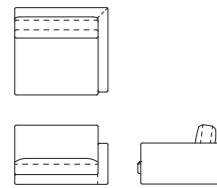

ONE ARM SOFA Left
W950×D900×H605 (mm)
[W37.5×D35.5×H23.9 (in)]

No.4E11-13

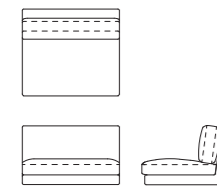

WIDE ARMLESS SOFA
W1,000×D900×H605 (mm)
[W39.4×D35.5×H23.9 (in)]

No.4E12-10

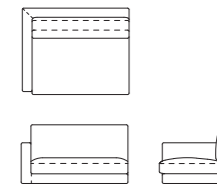

WIDE ONE ARM SOFA Right
W1,100×D900×H605 (mm)
[W43.4×D35.5×H23.9 (in)]

No.4E12-14

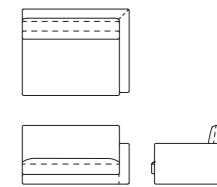

WIDE ONE ARM SOFA Left
W1,100×D900×H605 (mm)
[W43.4×D35.5×H23.9 (in)]

No.4E12-13

Sofa

ANGLED SOFA UNIT (Compatible with SCREW-TYPE LEG only)

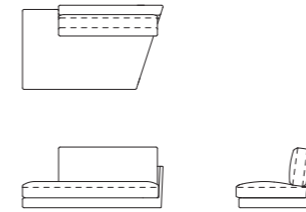

ARMLESS ANGLED SOFA Right
W1,420×D851×H605 (mm)
[W56.0×D33.6×H23.9 (in)]

No.4E38-04

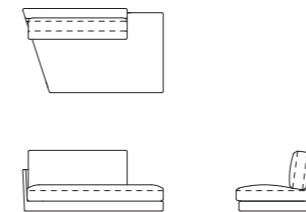

ARMLESS ANGLED SOFA Left
W1,420×D851×H605 (mm)
[W56.0×D33.6×H23.9 (in)]

No.4E38-03

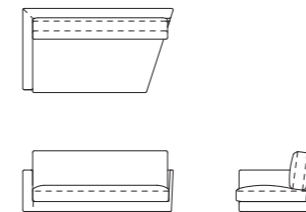

ONE ARM ANGLED SOFA Right
W1,520×D851×H605 (mm)
[W59.9×D33.6×H23.9 (in)]

No.4E38-14

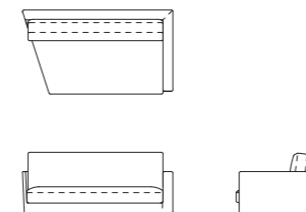

ONE ARM ANGLED SOFA Left
W1,520×D851×H605 (mm)
[W59.9×D33.6×H23.9 (in)]

No.4E38-13

Sofa

CORNER SOFA UNIT (Compatible with SCREW-TYPE LEG only)

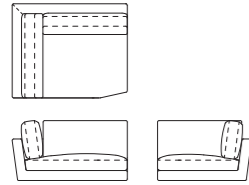

CORNER SOFA Right
W1,160×D950×H605 (mm)
[W45.7×D37.5×H23.9 (in)]

No.4E11-64

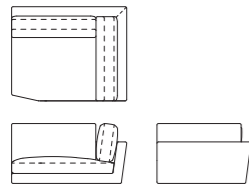

CORNER SOFA Left
W1,160×D950×H605 (mm)
[W45.7×D37.5×H23.9 (in)]

No.4E11-63

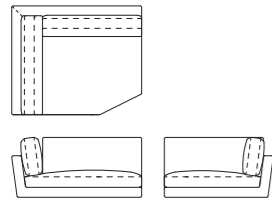

WIDE CORNER SOFA Right
W1,310×D1,100×H605 (mm)
[W51.6×D43.4×H23.9 (in)]

No.4E12-64

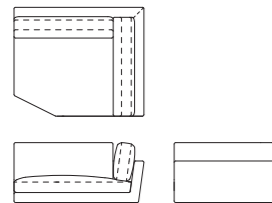

WIDE CORNER SOFA Left
W1,310×D1,100×H605 (mm)
[W51.6×D43.4×H23.9 (in)]

No.4E12-63

Sofa

CHAISE LONGUE 150 UNIT (Compatible with SCREW-TYPE LEG only)

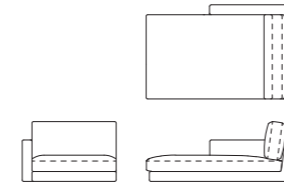

CHAISE LONGUE 150 Right
W950×D1,500×H605 (mm)
[W37.5×D59.1×H23.9 (in)]

No.4E11-74

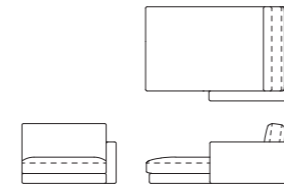

CHAISE LONGUE 150 Left
W950×D1,500×H605 (mm)
[W37.5×D59.1×H23.9 (in)]

No.4E11-73

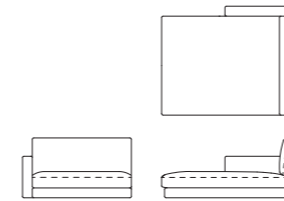

WIDE CHAISE LONGUE 150 Right
W1,100×D1,500×H605 (mm)
[W43.4×D59.1×H23.9 (in)]

No.4E12-74

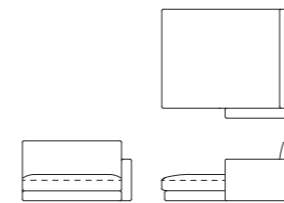

WIDE CHAISE LONGUE 150 Left
W1,100×D1,500×H605 (mm)
[W43.4×D59.1×H23.9 (in)]

No.4E12-73

Sofa

CHAISE LONGUE 180 UNIT (Compatible with SCREW-TYPE LEG only)

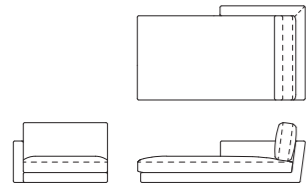

CHAISE LONGUE 180 Right
W950×D1,800×H605 (mm)
[W37.5×D70.9×H23.9 (in)]

No.4E11-84

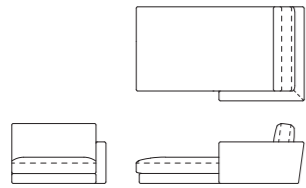

CHAISE LONGUE 180 Left
W950×D1,800×H605 (mm)
[W37.5×D70.9×H23.9 (in)]

No.4E11-83

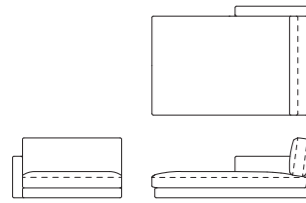

WIDE CHAISE LONGUE 180 Right
W1,100×D1,800×H605 (mm)
[W43.4×D70.9×H23.9 (in)]

No.4E12-84

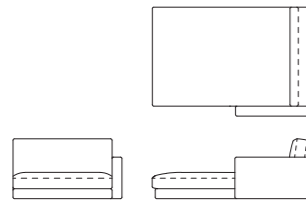

WIDE CHAISE LONGUE 180 Left
W1,100×D1,800×H605 (mm)
[W43.4×D70.9×H23.9 (in)]

No.4E12-83

Sofa

OTTOMAN UNIT & BOLSTER CUSHION

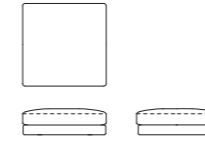

OTTOMAN 85
W850×D840×H265 (mm)
[W33.5×D33.1×H10.5 (in)]

No.4E13-15

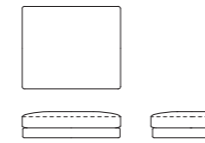

WIDE OTTOMAN 100
W1,000×D840×H265 (mm)
[W39.4×D33.1×H10.5 (in)]

No.4E13-25

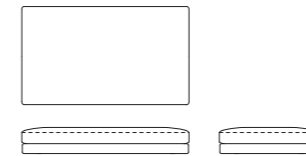

LARGE OTTOMAN 170
W1,700×D1,000×H265 (mm)
[W67.0×D39.4×H10.5 (in)]

No.4E13-35

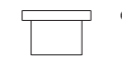

BOLSTER CUSHION
W700×D100×H450 (mm)
[W27.6×D4.0×H17.8 (in)]

No.4E14-00

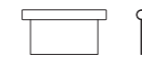

WIDE BOLSTER CUSHION
W850×D100×H450 (mm)
[W33.5×D4.0×H17.8 (in)]

No.4E14-01

Sofa

Cover

Covering function is available for cushion only.
Leather is not available for sofas and ottomans.

Tinted section is detachable.

cushion cover for ARMLESS SOFA		
cushion cover for ONE ARM SOFA Right		No.4E11-90
cushion cover for ONE ARM SOFA Left		
cushion cover for WIDE ARMLESS SOFA		
cushion cover for WIDE ONE ARM SOFA Right		No.4E12-90
cushion cover for WIDE ONE ARM SOFA Left		
cushion cover for ARMLESS ANGLED SOFA Right		No.4E38-97
cushion cover for ARMLESS ANGLED SOFA Left		No.4E38-96
cushion cover for ONE ARM ANGLED SOFA Right		No.4E38-94
cushion cover for ONE ARM ANGLED SOFA Left		No.4E38-93
cushion cover for CORNER SOFA Right		No.4E11-95
cushion cover for CORNER SOFA Left		No.4E11-96

Sofa

Cover

Covering function is available for cushion only.
Leather is not available for sofas and ottomans.

Tinted section is detachable.

cushion cover for WIDE CORNER SOFA Right		No.4E12-95
cushion cover for WIDE CORNER SOFA Left		No.4E12-96
cushion cover for CHAISE LONGUE 150 Right		No.4E11-93
cushion cover for CHAISE LONGUE 150 Left		
cushion cover for WIDE CHAISE LONGUE 150 Right		No.4E12-93
cushion cover for WIDE CHAISE LONGUE 150 Left		
cushion cover for CHAISE LONGUE 180 Right		No.4E11-94
cushion cover for CHAISE LONGUE 180 Left		
cushion cover for WIDE CHAISE LONGUE 180 Right		No.4E12-94
cushion cover for WIDE CHAISE LONGUE 180 Left		

Sofa

Cover

Covering function is available for cushion only.
Leather is not available for sofas and ottomans.

Tinted section is detachable.

cushion cover for OTTOMAN 85

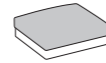

No.4E13-91

cushion cover for WIDE OTTOMAN 100

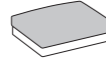

No.4E13-92

cushion cover for LARGE OTTOMAN 170

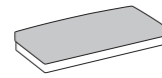

No.4E13-93

cover for BOLSTER CUSHION

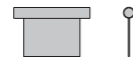

No.4E14-90

cover for WIDE BOLSTER CUSHION

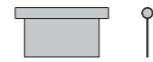

No.4E14-91

Sofa

LEG UNIT (Please check each sofa unit for leg compatibility.)



SCREW-TYPE LEG (set of 4)
φ42×H160 (mm)
[φ1.7×H6.3 (in)]

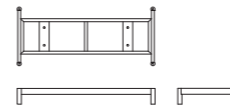

LEGGED FRAME FOR TWO SEATER
W1,402×D597×H160 (mm)
[W55.2×D23.6×H6.3 (in)]
Legs are made of wood.
Frame is made of steel.

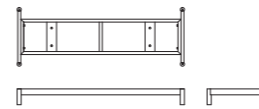













LEGGED FRAME FOR WIDE TWO SEATER
W1,702×D597×H160 (mm)
[W67.1×D23.6×H6.3 (in)]
Legs are made of wood.
Frame is made of steel.

beech	 whitish (NL-0)	 matte black (EC-1)		
oak	 bold whitish (NQ-0)	 bold black (BNK-1)	 bold charcoal (NU-0)	 bold gray (BOG-0)
	 clear (C-0)	 whitish (NL-0)	 natural black (NK-1)	 light gray (OG-0)
walnut	 clear (C-0)	 light brown (WB-1)		

beech	No.4E18-30	No.4E30-80		
oak	No.4E31-F0	No.4E31-80	No.4E31-K0	No.4E31-70
	No.4E19-20	No.4E19-30	No.4E19-80	No.4E19-70
walnut	No.4E20-60	No.4E20-20		
beech	No.4E15-36	No.4E32-86		
oak	No.4E33-F6	No.4E33-86	No.4E33-K6	No.4E33-76
	No.4E16-26	No.4E16-36	No.4E16-86	No.4E16-76
walnut	No.4E17-66	No.4E17-26		
beech	No.4E15-37	No.4E32-87		
oak	No.4E33-F7	No.4E33-87	No.4E33-K7	No.4E33-77
	No.4E16-27	No.4E16-37	No.4E16-87	No.4E16-77
walnut	No.4E17-67	No.4E17-27		

Sofa







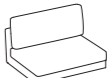

beech	 whitish (NL-0)	 matte black (EC-1)		
oak	 bold whitish (NQ-0)	 bold black (BNK-1)	 bold charcoal (NU-0)	 bold gray (BOG-0)
	 clear (C-0)	 whitish (NL-0)	 natural black (NK-1)	 light gray (OG-0)
walnut	 clear (C-0)	 light brown (WB-1)		

LEG UNIT (Please check each sofa unit for leg compatibility.)

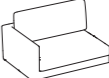
 <p>LEGGED FRAME FOR THREE SEATER W2,252×D597×H160 (mm) [W88.7×D23.6×H6.3 (in)] Legs are made of wood. Frame is made of steel.</p>	beech	No.4E15-38	No.4E32-88		
	oak	No.4E33-F8	No.4E33-88	No.4E33-K8	No.4E33-78
		No.4E16-28	No.4E16-38	No.4E16-88	No.4E16-78
walnut	No.4E17-68	No.4E17-28			
 <p>LEGGED FRAME FOR WIDE THREE SEATER W2,702×D597×H160 (mm) [W106.4×D23.6×H6.3 (in)] Legs are made of wood. Frame is made of steel.</p>	beech	No.4E15-39	No.4E32-89		
	oak	No.4E33-F9	No.4E33-89	No.4E33-K9	No.4E33-79
		No.4E16-29	No.4E16-39	No.4E16-89	No.4E16-79
walnut	No.4E17-69	No.4E17-29			
 <p>CONNECTING PLATE FOR SOFA W260×D145×H16 (mm) [W10.3×D5.8×H0.7 (in)] Made of steel.</p>		No.4E51-00			

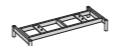





Sofa

Parts combination

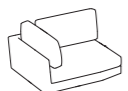
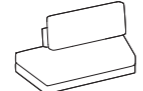
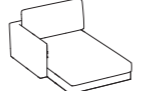
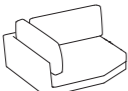
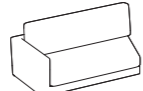
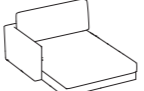
	 ARMLESS SOFA	 WIDE ARMLESS SOFA		
	 ONE ARM SOFA	 OTTOMAN 85	 WIDE ONE ARM SOFA	 WIDE OTTOMAN 100
 SCREW-TYPE LEG (set of 4)	●		●	
 LEGGED FRAME FOR TWO SEATER	●		—	
 LEGGED FRAME FOR THREE SEATER	●		—	
 LEGGED FRAME FOR WIDE TWO SEATER	—		●	
 LEGGED FRAME FOR WIDE THREE SEATER	—		●	

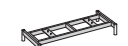

Sofa

Parts combination

	 CORNER SOFA  ARMLESS ANGLED SOFA  CHAISE LONGUE  WIDE CORNER SOFA  ONE ARM ANGLED SOFA  WIDE CHAISE LONGUE  LARGE OTTOMAN 170
 SCREW-TYPE LEG (set of 4)	●
 LEGGED FRAME FOR TWO SEATER	—
 LEGGED FRAME FOR THREE SEATER	—
 WIDE LEGGED FRAME FOR WIDE TWO SEATER	—
 WIDE LEGGED FRAME FOR WIDE THREE SEATER	—

Shelf

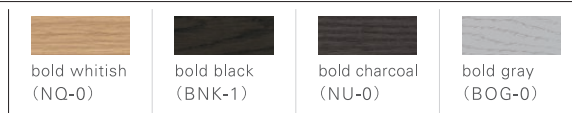
OPEN SHELF for Sofa

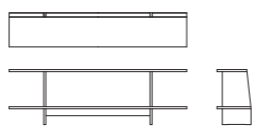
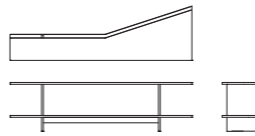
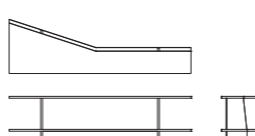
	 oak bold whitish (NO-0) bold black (BNK-1) bold charcoal (NU-0) bold gray (BOG-0) clear (C-0) whitish (NL-0) natural black (NK-1) light gray (OG-0)															
	 walnut clear (C-0) light brown (WB-1)															
 OPEN SHELF 180 W1,795×D345×H557 (mm) [W70.7×D13.6×H22.0 (in)] Solid Wood Top	<table border="1"> <tr> <td>oak</td> <td>No.6E11-F5</td> <td>No.6E11-85</td> <td>No.6E11-K5</td> <td>No.6E11-75</td> </tr> <tr> <td>oak</td> <td>No.6E09-25</td> <td>No.6E09-35</td> <td>No.6E09-85</td> <td>No.6E09-75</td> </tr> <tr> <td>walnut</td> <td>No.6E10-65</td> <td>No.6E10-25</td> <td></td> <td></td> </tr> </table>	oak	No.6E11-F5	No.6E11-85	No.6E11-K5	No.6E11-75	oak	No.6E09-25	No.6E09-35	No.6E09-85	No.6E09-75	walnut	No.6E10-65	No.6E10-25		
oak	No.6E11-F5	No.6E11-85	No.6E11-K5	No.6E11-75												
oak	No.6E09-25	No.6E09-35	No.6E09-85	No.6E09-75												
walnut	No.6E10-65	No.6E10-25														
 OPEN SHELF 210 W2,095×D345×H557 (mm) [W82.5×D13.6×H22.0 (in)] Solid Wood Top	<table border="1"> <tr> <td>oak</td> <td>No.6E11-F6</td> <td>No.6E11-86</td> <td>No.6E11-K6</td> <td>No.6E11-76</td> </tr> <tr> <td>oak</td> <td>No.6E09-26</td> <td>No.6E09-36</td> <td>No.6E09-86</td> <td>No.6E09-76</td> </tr> <tr> <td>walnut</td> <td>No.6E10-66</td> <td>No.6E10-26</td> <td></td> <td></td> </tr> </table>	oak	No.6E11-F6	No.6E11-86	No.6E11-K6	No.6E11-76	oak	No.6E09-26	No.6E09-36	No.6E09-86	No.6E09-76	walnut	No.6E10-66	No.6E10-26		
oak	No.6E11-F6	No.6E11-86	No.6E11-K6	No.6E11-76												
oak	No.6E09-26	No.6E09-36	No.6E09-86	No.6E09-76												
walnut	No.6E10-66	No.6E10-26														
 ANGLED OPEN SHELF 207 Right W2,073×D618×H557 (mm) [W81.7×D24.4×H22.0 (in)] Solid Wood Top	<table border="1"> <tr> <td>oak</td> <td>No.6E12-F4</td> <td>No.6E12-84</td> <td>No.6E12-K4</td> <td>No.6E12-74</td> </tr> <tr> <td>oak</td> <td>No.6E13-24</td> <td>No.6E13-34</td> <td>No.6E13-84</td> <td>No.6E13-74</td> </tr> <tr> <td>walnut</td> <td>No.6E14-64</td> <td>No.6E14-24</td> <td></td> <td></td> </tr> </table>	oak	No.6E12-F4	No.6E12-84	No.6E12-K4	No.6E12-74	oak	No.6E13-24	No.6E13-34	No.6E13-84	No.6E13-74	walnut	No.6E14-64	No.6E14-24		
oak	No.6E12-F4	No.6E12-84	No.6E12-K4	No.6E12-74												
oak	No.6E13-24	No.6E13-34	No.6E13-84	No.6E13-74												
walnut	No.6E14-64	No.6E14-24														
 ANGLED OPEN SHELF 207 Left W2,073×D618×H557 (mm) [W81.7×D24.4×H22.0 (in)] Solid Wood Top	<table border="1"> <tr> <td>oak</td> <td>No.6E12-F3</td> <td>No.6E12-83</td> <td>No.6E12-K3</td> <td>No.6E12-73</td> </tr> <tr> <td>oak</td> <td>No.6E13-23</td> <td>No.6E13-33</td> <td>No.6E13-83</td> <td>No.6E13-73</td> </tr> <tr> <td>walnut</td> <td>No.6E14-63</td> <td>No.6E14-23</td> <td></td> <td></td> </tr> </table>	oak	No.6E12-F3	No.6E12-83	No.6E12-K3	No.6E12-73	oak	No.6E13-23	No.6E13-33	No.6E13-83	No.6E13-73	walnut	No.6E14-63	No.6E14-23		
oak	No.6E12-F3	No.6E12-83	No.6E12-K3	No.6E12-73												
oak	No.6E13-23	No.6E13-33	No.6E13-83	No.6E13-73												
walnut	No.6E14-63	No.6E14-23														

Table

beech		whitish (NL-0)
oak		bold whitish (NQ-0)
		clear (C-0)
walnut		whitish (NL-0)
		light brown (WB-1)

TABLE 85 Low (square)
W850×D850×H700
intercrural width : 548 (mm)
[W33.5×D33.5×H27.6
intercrural width : 21.6 (in)]
Veneered Top

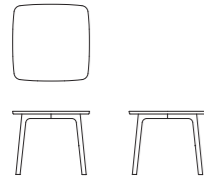

beech	No.1954-31	
oak	No.1E40-F1	
	No.1974-21	No.1974-31
walnut	No.1984-61	No.1984-21

TABLE 85 High (square)
W850×D850×H720
intercrural width : 548 (mm)
[W33.5×D33.5×H28.4
intercrural width : 21.6 (in)]
Veneered Top

beech	No.1954-31-0072	
oak	No.1E40-F1-0072	
	No.1974-21-0072	No.1974-31-0072
walnut	No.1984-61-0072	No.1984-21-0072

TABLE 130 Low (rectangular)
W1,300×D850×H700
intercrural width : 975 (mm)
[W51.2×D33.5×H27.6
intercrural width : 38.4 (in)]
Veneered Top

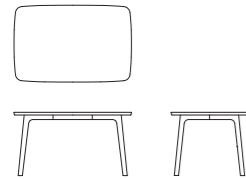

beech	No.1954-32	
oak	No.1E40-F2	
	No.1974-22	No.1974-32
walnut	No.1984-62	No.1984-22

TABLE 130 High (rectangular)
W1,300×D850×H720
intercrural width : 975 (mm)
[W51.2×D33.5×H28.4
intercrural width : 38.4 (in)]
Veneered Top

beech	No.1954-32-0072	
oak	No.1E40-F2-0072	
	No.1974-22-0072	No.1974-32-0072
walnut	No.1984-62-0072	No.1984-22-0072

Table

beech		whitish (NL-0)
oak		bold whitish (NQ-0)
		clear (C-0)
walnut		whitish (NL-0)
		light brown (WB-1)

TABLE 160 Low (rectangular)
W1,600×D850×H700
intercrural width : 1,172 (mm)
[W63.0×D33.5×H27.6
intercrural width : 46.2 (in)]
Veneered Top

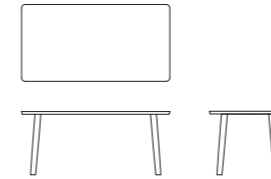

beech	No.1955-34	
oak	No.1E42-F4	
	No.1975-24	No.1975-34
walnut	No.1985-64	No.1985-24

TABLE 160 High (rectangular)
W1,600×D850×H720
intercrural width : 1,172 (mm)
[W63.0×D33.5×H28.4
intercrural width : 46.2 (in)]
Veneered Top

beech	No.1955-34-0072	
oak	No.1E42-F4-0072	
	No.1975-24-0072	No.1975-34-0072
walnut	No.1985-64-0072	No.1985-24-0072

TABLE 180 Low (rectangular)
W1,800×D850×H700
intercrural width : 1,267 (mm)
[W70.9×D33.5×H27.6
intercrural width : 49.9 (in)]
Veneered Top

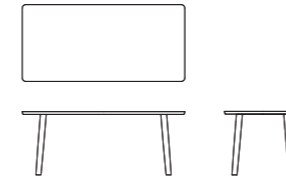

beech	No.1955-35	
oak	No.1E42-F5	
	No.1975-25	No.1975-35
walnut	No.1985-65	No.1985-25

TABLE 180 High (rectangular)
W1,800×D850×H720
intercrural width : 1,267 (mm)
[W70.9×D33.5×H28.4
intercrural width : 49.9 (in)]
Veneered Top

beech	No.1955-35-0072	
oak	No.1E42-F5-0072	
	No.1975-25-0072	No.1975-35-0072
walnut	No.1985-65-0072	No.1985-25-0072

Table

beech		
oak		
		
walnut		

EXTENSION TABLE Low (rectangular)
 W2,200 · 1,800 × D850 × H700
 intercrural width : 1,300 (mm)
 [W86.7 · 70.9 × D33.5 × H27.6
 intercrural width : 51.2 (in)]
 Veneered Top

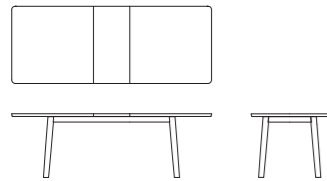

EXTENSION TABLE High (rectangular)
 W2,200 · 1,800 × D850 × H720
 intercrural width : 1,300 (mm)
 [W86.7 · 70.9 × D33.5 × H28.4
 intercrural width : 51.2 (in)]
 Veneered Top

beech	No.1956-30	
oak	No.1E44-F0	
	No.1976-20	No.1976-30
walnut	No.1986-60	No.1986-20
beech	No.1956-30-0072	
oak	No.1E44-F0-0072	
	No.1976-20-0072	No.1976-30-0072
walnut	No.1986-60-0072	No.1986-20-0072

ROUND TABLE Low
 Φ1,200 × H700
 intercrural width : 604 (mm)
 [Φ47.3 × H27.6
 intercrural width : 23.8 (in)]
 Veneered Top

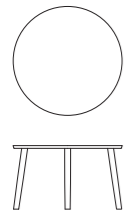

ROUND TABLE High
 Φ1,200 × H720
 intercrural width : 604 (mm)
 [Φ47.3 × H28.4
 intercrural width : 23.8 (in)]
 Veneered Top

beech	No.1960-30	
oak	No.1E67-F0	
	No.1980-20	No.1980-30
walnut	No.1990-60	No.1990-20
beech	No.1960-30-0072	
oak	No.1E67-F0-0072	
	No.1980-20-0072	No.1980-30-0072
walnut	No.1990-60-0072	No.1990-20-0072

Table

beech			
oak			
			
walnut			



SIDE TABLE
 Φ450 × H500 (mm)
 [Φ17.8 × H19.7 (in)]
 (Weight support ability : 20kg)
 Veneered Top

beech	No.3055-30		
oak	No.3E43-F0	No.3E43-80	No.3E43-K0
	No.3057-20	No.3057-30	No.3057-80
walnut	No.3058-60	No.3058-20	
beech	No.3960-36		
oak	No.3E45-F6	No.3E45-86	No.3E45-K6
	No.3980-26	No.3980-36	No.3980-86
walnut	No.3990-66	No.3990-26	



END TABLE
 Φ670 × H550 (mm)
 [Φ26.4 × H21.7 (in)]
 Veneered Top

beech



urethane finish, whitish (NL-0) urethane finish, matte black (EC-1) urethane finish, matte white (EA-1)

ash

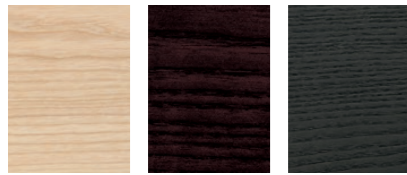

urethane finish, whitish (NL-0) urethane finish, dark brown (WS-1) urethane finish, natural black (NK-1)

oak

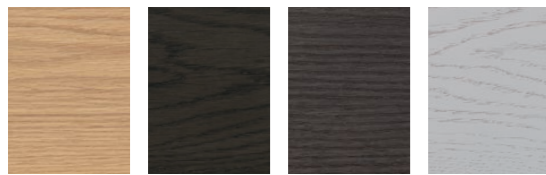

urethane finish, bold whitish (NQ-0) urethane finish, bold black (BNK-1) urethane finish, bold charcoal (NU-0) urethane finish, bold gray (BOG-0)

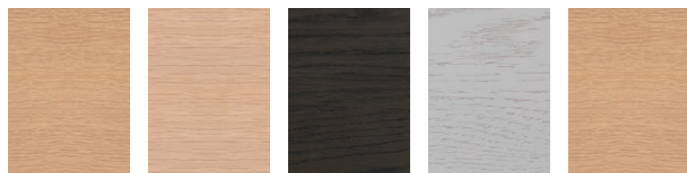

urethane finish, clear (C-0) urethane finish, whitish (NL-0) urethane finish, natural black (NK-1) urethane finish, light gray (OG-0) oil finish, clear (NB-1)

walnut

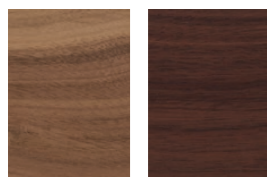

urethane finish, clear (C-0) urethane finish, light brown (WB-1)

stainless steel



chrome plated brushed black powder coated

steel

















black powder coated







M-01	TWILL											
			#4586	#4570	#4580	#4583	#4573	#4581	#4571	#4588	#4589	
M-02	Remix											
			#3317	#3310	#3313	#3311	#3314	#3318	#3E01	#3319	#3E02	#3329
	SAGA											
			#4162	#4160	#4163	#4167	#4169					
	MAYA											
			#3575	#3579	#3572	#3576	#3570	#3578	#3589			
	Livorno											
			#3E03	#3E04	#3E05	#3E06						
M-03	BAROJA	*1										
			#3E07	#3E08	#3E09	#3E10	#3E11					
	Merit											
			#2E02	#2E03	#2E04	#2E05	#2E06					
M-04	Melange Nap											
			#4136	#4E19	#4133	#4E20	#4E21	#4137	#4129			
	Quay											
			#4E11	#4E12	#4E13	#4E14	#4E15	#4E16	#4E17	#4E18		
M-05	Divina MD											
			#4725	#4722	#4720	#4721	#4724	#4729	#4719			
	Tonus											
			#4E08									
M-06	Hallingdal											
			#2E08	#2936	#2932	#2E09	#2930	#2934	#2E07	#2949	#2939	#2E10
L-01	leather	*2										
			#5191									
	tanned leather	*2										
			#5006									
L-02	elmosoft	*2										
			#5025	#5035	#5022	#5032	#5037	#5020	#5024			

*1 BAROJA is not available for HIROSHIMA ARMCHAIR Stackable (cushioned).
*2 Leather is not available for sofas.

Chair

		beech	 whitish (NL-0)		
		oak	 bold whitish (NQ-0)	 bold black (BNK-1)	 bold charcoal (NU-0)
			 clear (C-0)	 whitish (NL-0)	 natural black (NK-1)
		walnut	 clear (C-0)	 light brown (WB-1)	
	CHAIR (wooden seat) W460×D530×H787×SH440 (mm) [W18.2×D20.9×H31.0×SH17.4 (in)] Veneered Plywood	beech	No.2000-30		
		oak	No.2E60-F0	No.2E60-80	No.2E60-K0
			No.2040-20	No.2040-30	No.2040-80
		walnut	No.2240-60	No.2240-20	
	CHAIR (cushioned seat) W460×D530×H773×SH440 (mm) [W18.2×D20.9×H30.5×SH17.4 (in)] Veneered Plywood	beech	No.2011-30		
		oak	No.2E62-F0	No.2E62-80	No.2E62-K0
			No.2061-20	No.2061-30	No.2061-80
		walnut	No.2251-60	No.2251-20	
	CHAIR (cushioned) W460×D530×H773×SH440 (mm) [W18.2×D20.9×H30.5×SH17.4 (in)] Veneered Plywood	beech	No.2005-30		
		oak	No.2E64-F0	No.2E64-80	No.2E64-K0
			No.2045-20	No.2045-30	No.2045-80
		walnut	No.2245-60	No.2245-20	
	ARMCHAIR (wooden seat) W589×D577×H887×SH450 (mm) [W23.2×D22.8×H35.0×SH17.8 (in)] Veneered Plywood	beech	No.2325-31		
		oak	No.2E66-F1	No.2E66-81	No.2E66-K1
			No.2385-21	No.2385-31	No.2385-81
		walnut	No.2395-61	No.2395-21	
	ARMCHAIR (cushioned) W589×D577×H887×SH465 (mm) [W23.2×D22.8×H35.0×SH18.4 (in)] Veneered Plywood	beech	No.2327-31		
		oak	No.2E68-F1	No.2E68-81	No.2E68-K1
			No.2387-21	No.2387-31	No.2387-81
		walnut	No.2397-61	No.2397-21	

Table

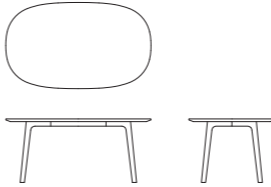
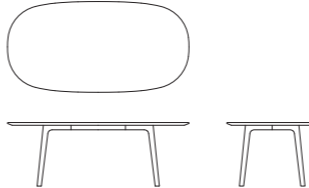
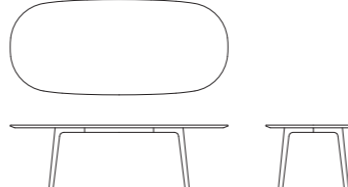
		beech	 whitish (NL-0)		
		oak	 bold whitish (NQ-0)		
			 clear (C-0)	 whitish (NL-0)	
		walnut	 clear (C-0)	 light brown (WB-1)	
	TABLE 160 (oval) W1,600×D950×H720 intercrural width: 1,045 (mm) [W63.0×D37.5×H28.4 intercrural width: 41.2 (in)] Veneered Top	beech	No.1010-34		
		oak	No.1E46-F4		
			No.1040-24	No.1040-34	
		walnut	No.1240-64	No.1240-24	
	TABLE 200 (oval) W2,000×D1,000×H720 intercrural width: 1,104 (mm) [W78.8×D39.4×H28.4 intercrural width: 43.5 (in)] Veneered Top	beech	No.1010-36		
		oak	No.1E46-F6		
			No.1040-26	No.1040-36	
		walnut	No.1240-66	No.1240-26	
	TABLE 240 (oval) W2,400×D1,050×H720 intercrural width: 1,306 (mm) [W94.5×D41.4×H28.4 intercrural width: 51.5 (in)] Veneered Top	beech	No.1010-38		
		oak	No.1E46-F8		
			No.1040-28	No.1040-38	
		walnut	No.1240-68	No.1240-28	

beech

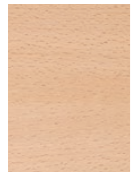

urethane finish,
whitish
(NL-0)

oak

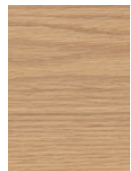

urethane finish,
bold whitish
(NQ-0)



urethane finish,
bold black
(BNK-1)



urethane finish,
bold charcoal
(NU-0)

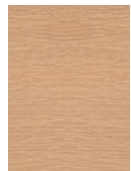

urethane finish,
clear
(C-0)

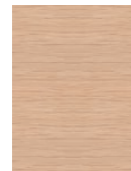

urethane finish,
whitish
(NL-0)

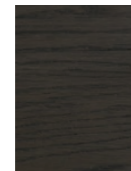

urethane finish,
natural black
(NK-1)

walnut

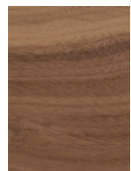

urethane finish,
clear
(C-0)

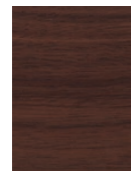



urethane finish,
light brown
(WB-1)

M-01	TWILL										
		#4586	#4570	#4580	#4583	#4573	#4581	#4571	#4588	#4589	
M-02	Remix										
		#3317	#3310	#3313	#3311	#3314	#3318	#3E01	#3319	#3E02	#3329
	SAGA										
		#4162	#4160	#4163	#4167	#4169					
	MAYA										
		#3575	#3579	#3572	#3576	#3570	#3578	#3589			
	Livorno	not available									
M-03	BAROJA	not available									
	Merit	not available									
M-04	Melange Nap										
		#4136	#4E19	#4133	#4E20	#4E21	#4137	#4129			
	Quay	not available									
M-05	Divina MD										
		#4725	#4722	#4720	#4721	#4724	#4729	#4719			
	Tonus										
		#4E08									
M-06	Hallingdal										
		#2E08	#2936	#2932	#2E09	#2930	#2934	#2E07	#2949	#2939	#2E10
L-01	leather	*1									
			#5191								
	tanned leather	*1									
			#5006								
L-02	elmosoft	*1									
			#5025	#5035	#5022	#5032	#5037	#5020	#5024		

*1 Leather is not available for armchair (cushioned).

Sofa • Ottoman

beech	 whitish (NL-0)		
oak	 bold whitish (NQ-0)	 bold black (BNK-1)	 bold charcoal (NU-0)
	 clear (C-0)	 whitish (NL-0)	 natural black (NK-1)
walnut	 clear (C-0)	 light brown (WB-1)	

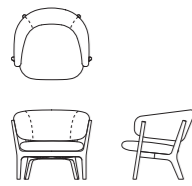

ARM SOFA
W881×D789×H763×SH420 (mm)
[W34.7×D31.1×H30.1×SH16.6 (in)]

beech	No.4116-31		
oak	No.4E35-F1	No.4E35-81	No.4E35-K1
	No.4119-21	No.4119-31	No.4119-81
walnut	No.4170-61	No.4170-21	

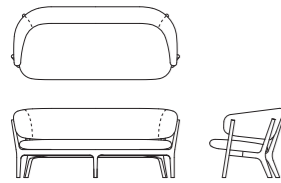

TWO SEATER SOFA
W1,854×D789×H763×SH420 (mm)
[W73.0×D31.1×H30.1×SH16.6 (in)]

beech	No.4116-32		
oak	No.4E35-F2	No.4E35-82	No.4E35-K2
	No.4119-22	No.4119-32	No.4119-82
walnut	No.4170-62	No.4170-22	

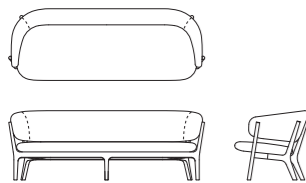

THREE SEATER SOFA
W2,157×D789×H763×SH420 (mm)
[W85.0×D31.1×H30.1×SH16.6 (in)]

beech	No.4116-33		
oak	No.4E35-F3	No.4E35-83	No.4E35-K3
	No.4119-23	No.4119-33	No.4119-83
walnut	No.4170-63	No.4170-23	

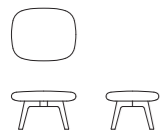

OTTOMAN
W710×D580×H420 (mm)
[W28.0×D22.9×H16.6 (in)]

beech	No.4116-35		
oak	No.4E35-F5	No.4E35-85	No.4E35-K5
	No.4119-25	No.4119-35	No.4119-85
walnut	No.4170-65	No.4170-25	

Table

beech	 whitish (NL-0)	
oak	 bold whitish (NQ-0)	
	 clear (C-0)	 whitish (NL-0)
walnut	 clear (C-0)	 light brown (WB-1)



COFFEE TABLE 120
Φ1,200×H400 (mm)
[Φ47.3×H15.8 (in)]
Veneered Top

beech	No.3026-36	
oak	No.3E47-F6	
	No.3029-26	No.3029-36
walnut	No.3030-66	No.3030-26

beech

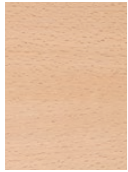

urethane finish,
whitish
(NL-0)

oak



urethane finish,
bold whitish
(NQ-0)



urethane finish,
bold black
(BNK-1)



urethane finish,
bold charcoal
(NU-0)

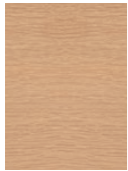

urethane finish,
clear
(C-0)

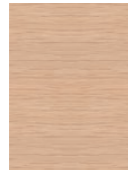

urethane finish,
whitish
(NL-0)

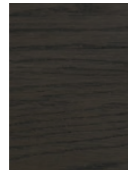

urethane finish,
natural black
(NK-1)







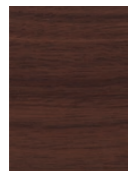

























walnut











urethane finish,
clear
(C-0)





urethane finish,
light brown
(WB-1)

M-01	TWILL	not available							
M-02	Remix	not available							
	SAGA								
		#4162	#4160	#4163	#4167	#4169			
	MAYA	not available							
	Livorno								
		#3E03	#3E04	#3E05	#3E06				
M-03	BAROJA								
		#3E07	#3E08	#3E09	#3E10	#3E11			
	Merit	not available							
M-04	Melange Nap								
		#4136	#4E19	#4133	#4E20	#4E21	#4137	#4129	
	Quay								
		#4E11	#4E12	#4E13	#4E14	#4E15	#4E16	#4E17	#4E18
M-05	Divina MD								
		#4725	#4722	#4720	#4721	#4724	#4729	#4719	
	Tonus								
		#4E08							
M-06	Hallingdal	not available							
L-01	leather	not available							
	tanned leather	not available							
L-02	elmosoft	not available							

Tako		NAOTO FUKASAWA		
Chair	oak	 bold whitish (NQ-0)	 bold black (BNK-1)	 bold charcoal (NU-0)
		 clear (C-0)	 whitish (NL-0)	 natural black (NK-1)
	walnut	 clear (C-0)	 light brown (WB-1)	

	ARMCHAIR (wooden seat) W600×D564×H795×SH449 (mm) [W23.7×D22.3×H31.3×SH17.7 (in)]	oak	No.2F18-F1	No.2F18-81	No.2F18-K1
			No.2543-21	No.2543-31	No.2543-81
		walnut	No.2563-61	No.2563-21	

	ARMCHAIR (cushioned) W600×D564×H795×SH460 (mm) [W23.7×D22.3×H31.3×SH18.2 (in)]	oak	No.2F19-F1	No.2F19-81	No.2F19-K1
			No.2E01-21	No.2E01-31	No.2E01-81
		walnut	No.2E02-61	No.2E02-21	

Tako		NAOTO FUKASAWA	
Table	oak	 bold whitish (NQ-0)	
		 clear (C-0)	 whitish (NL-0)
	walnut	 clear (C-0)	 light brown (WB-1)

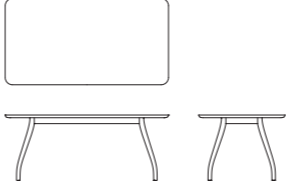
	TABLE 180 (rectangular) W1,800×D950×H720 intercrural width: 1,157 (mm) [W70.9×D37.5×H28.4 intercrural width: 45.6 (in)] Solid Wood Top	oak	No.1E81-F5	
			No.1543-25	No.1543-35
		walnut	No.1563-65	No.1563-25

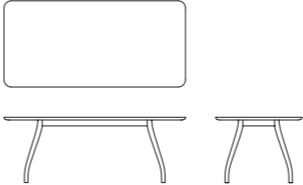
	TABLE 200 (rectangular) W2,000×D950×H720 intercrural width: 1,157 (mm) [W78.8×D37.5×H28.4 intercrural width: 45.6 (in)] Solid Wood Top	oak	No.1E81-F6	
			No.1543-26	No.1543-36
		walnut	No.1563-66	No.1563-26

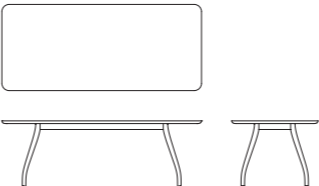
	TABLE 220 (rectangular) W2,200×D950×H720 intercrural width: 1,357 (mm) [W86.7×D37.5×H28.4 intercrural width: 53.5 (in)] Solid Wood Top	oak	No.1E81-F7	
			No.1543-27	No.1543-37
		walnut	No.1563-67	No.1563-27

	TABLE 240 (rectangular) W2,400×D950×H720 intercrural width: 1,557 (mm) [W94.5×D37.5×H28.4 intercrural width: 61.3 (in)] Solid Wood Top	oak	No.1E81-F8	
			No.1543-28	No.1543-38
		walnut	No.1563-68	No.1563-28

Table (ceramic top)

ceramic (top)	 CALACATTA	 DARK MARQUINA		
oak (leg)	 bold whitish (NQ-0)	 bold whitish (NQ-0)		
	 clear (C-0)	 whitish (NL-0)	 clear (C-0)	 whitish (NL-0)
walnut (leg)	 clear (C-0)	 light brown (WB-1)	 clear (C-0)	 light brown (WB-1)

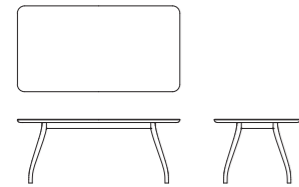

TABLE 180 (rectangular)
W1,800×D950×H726
intercrural width: 1,157 (mm)
[W70.9×D37.5×H28.6
intercrural width: 45.6 (in)]
Ceramic Top

oak

No.1E82-F5

No.1E83-F5

No.1E11-25

No.1E11-35

No.1E12-25

No.1E12-35

walnut

No.1E13-65

No.1E13-25

No.1E14-65

No.1E14-25

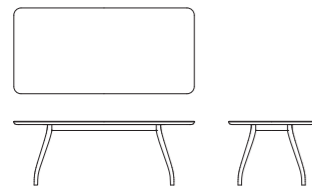

TABLE 200 (rectangular)
W2,000×D950×H726
intercrural width: 1,157 (mm)
[W78.8×D37.5×H28.6
intercrural width: 45.6 (in)]
Ceramic Top

oak

No.1E82-F6

No.1E83-F6

No.1E11-26

No.1E11-36

No.1E12-26

No.1E12-36

walnut

No.1E13-66

No.1E13-26

No.1E14-66

No.1E14-26

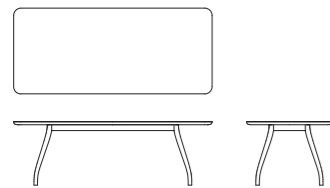

TABLE 220 (rectangular)
W2,200×D950×H726
intercrural width: 1,357 (mm)
[W86.7×D37.5×H28.6
intercrural width: 53.5 (in)]
Ceramic Top

oak

No.1E82-F7

No.1E83-F7

No.1E11-27

No.1E11-37

No.1E12-27

No.1E12-37

walnut

No.1E13-67

No.1E13-27

No.1E14-67

No.1E14-27

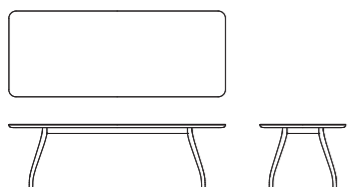

TABLE 240 (rectangular)
W2,400×D950×H726
intercrural width: 1,557 (mm)
[W94.5×D37.5×H28.6
intercrural width: 61.3 (in)]
Ceramic Top

oak

No.1E82-F8

No.1E83-F8

No.1E11-28

No.1E11-38

No.1E12-28

No.1E12-38

walnut

No.1E13-68

No.1E13-28

No.1E14-68

No.1E14-28

Table

oak	 bold whitish (NQ-0)
	 clear (C-0)  whitish (NL-0)
walnut	 clear (C-0)  light brown (WB-1)



ROUND TABLE 120
Φ1,200×H720
intercrural width: 397 (mm)
[Φ47.3×H28.4
intercrural width: 15.7 (in)]
Solid Wood Top

oak

No.1E84-F1

No.1540-21

No.1540-31

walnut

No.1590-61

No.1590-21

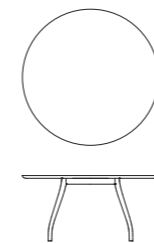

ROUND TABLE 150
Φ1,500×H720
intercrural width: 539 (mm)
[Φ59.1×H28.4
intercrural width: 21.3 (in)]
Solid Wood Top

oak

No.1E84-F2

No.1540-22

No.1540-32

walnut

No.1590-62

No.1590-22

Table (ceramic top)

ceramic (top)	 CALACATTA		 DARK MARQUINA	
	 bold whitish (NQ-0)		 bold whitish (NQ-0)	
oak (leg)	 clear (C-0)	 whitish (NL-0)	 clear (C-0)	 whitish (NL-0)
	 clear (C-0)	 light brown (WB-1)	 clear (C-0)	 light brown (WB-1)

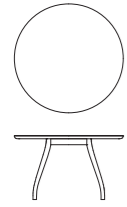

ROUND TABLE 120
 Φ1,200×H726
 intercrural width : 397 (mm)
 [Φ47.3×H28.6
 intercrural width : 15.7 (in)]
 Ceramic Top

oak	No.1E85-F1		No.1E86-F1	
	No.1E07-21	No.1E07-31	No.1E08-21	No.1E08-31
walnut	No.1E09-61	No.1E09-21	No.1E10-61	No.1E10-21

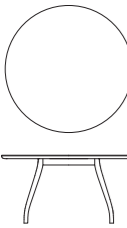

ROUND TABLE 140
 Φ1,400×H726
 intercrural width : 539 (mm)
 [Φ55.2×H28.6
 intercrural width : 21.3 (in)]
 Ceramic Top

oak	No.1E85-F2		No.1E86-F2	
	No.1E07-22	No.1E07-32	No.1E08-22	No.1E08-32
walnut	No.1E09-62	No.1E09-22	No.1E10-62	No.1E10-22

ceramic

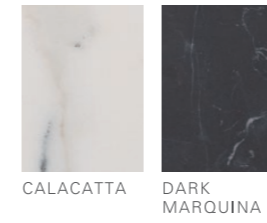

oak



walnut



Tako		NAOTO FUKASAWA									
M-01	TWILL										
M-02	Remix										
	SAGA										
	MAYA										
	Livorno										
M-03	BAROJA										
	Merit										
M-04	Melange Nap										
	Quay										
M-05	Divina MD										
	Tonus										
M-06	Hallingdal										
L-01	leather										
	tanned leather										
L-02	elmosoft										

MEGURO		NAOTO FUKASAWA			
Chair • Ottoman					
	LOUNGE CHAIR W737×D707×H765×SH383 (mm) [W29.1×D27.9×H30.2×SH15.1 (in)]	oak	No.4E55-F1	No.4E55-81	No.4E55-K1
			No.4090-21	No.4090-31	No.4090-81
		walnut	No.4291-61	No.4291-21	
	OTTOMAN W562×D400×H401×SH386 (mm) [W22.2×D15.8×H15.8×SH15.2 (in)]	oak	No.4E56-F5	No.4E56-85	No.4E56-K5
			No.4E36-25	No.4E36-35	No.4E36-85
		walnut	No.4E37-65	No.4E37-25	

oak



urethane finish, bold whitish (NQ-0) urethane finish, bold black (BNK-1) urethane finish, bold charcoal (NU-0)

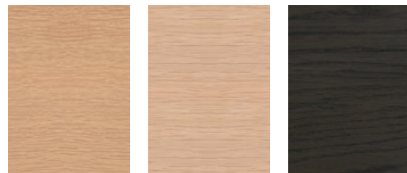

urethane finish, clear (C-0) urethane finish, whitish (NL-0) urethane finish, natural black (NK-1)



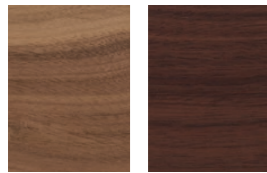

walnut



urethane finish, clear (C-0) urethane finish, light brown (WB-1)

M-01	TWILL										
		#4586	#4570	#4580	#4583	#4573	#4581	#4571	#4588	#4589	
M-02	Remix										
		#3317	#3310	#3313	#3311	#3314	#3318	#3E01	#3319	#3E02	#3329
	SAGA										
		#4162	#4160	#4163	#4167	#4169					
	MAYA										
		#3575	#3579	#3572	#3576	#3570	#3578	#3589			
	Livorno										
		#3E03	#3E04	#3E05	#3E06						
M-03	BAROJA										
		#3E07	#3E08	#3E09	#3E10	#3E11					
	Merit										
		#2E02	#2E03	#2E04	#2E05	#2E06					
M-04	Melange Nap										
		#4136	#4E19	#4133	#4E20	#4E21	#4137	#4129			
	Quay										
		#4E11	#4E12	#4E13	#4E14	#4E15	#4E16	#4E17	#4E18		
M-05	Divina MD										
		#4725	#4722	#4720	#4721	#4724	#4729	#4719			
	Tonus										
		#4E08									
M-06	Hallingdal										
		#2E08	#2936	#2932	#2E09	#2930	#2934	#2E07	#2949	#2939	#2E10
L-01	leather										
		#5191									
	tanned leather	not available									
L-02	elmosoft										
		#5025	#5035	#5022	#5032	#5037	#5020	#5024			

Chair

maple			
	clear (C-0)	natural black (NK-1)	
ash			
	whitish (NL-0)	natural black (NK-1)	
oak			
	bold whitish (NQ-0)	bold black (BNK-1)	bold charcoal (NU-0)
			
	clear (C-0)	whitish (NL-0)	natural black (NK-1)



CHAIR (webbing seat)
W468×D467×H782×SH450 (mm)
[W18.5×D18.4×H30.8×SH17.8 (in.)]

maple	No.2530-20	No.2530-80	
ash	No.2420-30	No.2420-80	
oak	No.2F20-F0	No.2F20-80	No.2F20-K0
	No.2510-20	No.2510-30	No.2510-80



CHAIR (mesh seat)
W468×D467×H782×SH450 (mm)
[W18.5×D18.4×H30.8×SH17.8 (in.)]

maple	No.2532-20	No.2532-80	
ash	No.2422-30	No.2422-80	
oak	No.2F21-F0	No.2F21-80	No.2F21-K0
	No.2512-20	No.2512-30	No.2512-80



CHAIR (paper cord)
W468×D467×H782×SH453 (mm)
[W18.5×D18.4×H30.8×SH17.9 (in.)]

maple	No.2E16-20	No.2E16-80	
ash	No.2E17-30	No.2E17-80	
oak	No.2F22-F0	No.2F22-80	No.2F22-K0
	No.2E18-20	No.2E18-30	No.2E18-80



CHAIR (cushioned)
W468×D467×H782×SH467 (mm)
[W18.5×D18.4×H30.8×SH18.4 (in.)]

maple	No.2531-20	No.2531-80	
ash	No.2421-30	No.2421-80	
oak	No.2F23-F0	No.2F23-80	No.2F23-K0
	No.2511-20	No.2511-30	No.2511-80



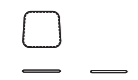

seat cover for CHAIR No.2501-90



CUSHION for CHAIR
W400×D385×H23 (mm)
[W15.8×D15.2×H1.0 (in.)]
leather only

No.2E16-90

Chair

maple			
	clear (C-0)	natural black (NK-1)	
ash			
	whitish (NL-0)	natural black (NK-1)	
oak			
	bold whitish (NQ-0)	bold black (BNK-1)	bold charcoal (NU-0)
			
	clear (C-0)	whitish (NL-0)	natural black (NK-1)



ARMCHAIR (webbing seat)
W522×D478×H798×SH450
arm height : 640 (mm)
[W20.6×D18.9×H31.5×SH17.8
arm height : 25.2 (in.)]

maple	No.2530-21	No.2530-81	
ash	No.2420-31	No.2420-81	
oak	No.2F20-F1	No.2F20-81	No.2F20-K1
	No.2510-21	No.2510-31	No.2510-81



ARMCHAIR (mesh seat)
W522×D478×H798×SH450
arm height : 640 (mm)
[W20.6×D18.9×H31.5×SH17.8
arm height : 25.2 (in.)]

maple	No.2532-21	No.2532-81	
ash	No.2422-31	No.2422-81	
oak	No.2F21-F1	No.2F21-81	No.2F21-K1
	No.2512-21	No.2512-31	No.2512-81



ARMCHAIR (paper cord)
W522×D478×H798×SH453
arm height : 640 (mm)
[W20.6×D18.9×H31.5×SH17.9
arm height : 25.2 (in.)]

maple	No.2E16-21	No.2E16-81	
ash	No.2E17-31	No.2E17-81	
oak	No.2F22-F1	No.2F22-81	No.2F22-K1
	No.2E18-21	No.2E18-31	No.2E18-81







ARMCHAIR (cushioned)
W522×D478×H798×SH467
arm height : 640 (mm)
[W20.6×D18.9×H31.5×SH18.4
arm height : 25.2 (in.)]

maple	No.2531-21	No.2531-81	
ash	No.2421-31	No.2421-81	
oak	No.2F23-F1	No.2F23-81	No.2F23-K1
	No.2511-21	No.2511-31	No.2511-81

seat cover for ARMCHAIR No.2501-91

Bar Stool Mid

maple	 clear (C-0)	 natural black (NK-1)	
ash	 whitish (NL-0)	 natural black (NK-1)	
oak	 bold whitish (NQ-0)	 bold black (BNK-1)	 bold charcoal (NU-0)
	 clear (C-0)	 whitish (NL-0)	 natural black (NK-1)

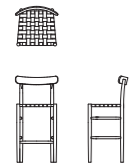

BAR STOOL Mid (webbing seat)
W468×D435×H948×SH637 (mm)
[W18.5×D17.2×H37.4×SH25.1 (in.)]

maple	No.2630-20	No.2630-80	
ash	No.2470-30	No.2470-80	
oak	No.2F24-F0	No.2F24-80	No.2F24-K0
	No.2580-20	No.2580-30	No.2580-80

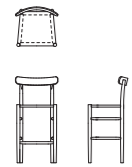

BAR STOOL Mid (mesh seat)
W468×D435×H948×SH637 (mm)
[W18.5×D17.2×H37.4×SH25.2 (in.)]

maple	No.2633-20	No.2633-80	
ash	No.2472-30	No.2472-80	
oak	No.2F25-F0	No.2F25-80	No.2F25-K0
	No.2582-20	No.2582-30	No.2582-80

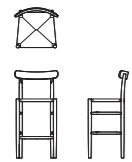

BAR STOOL Mid (paper cord)
W468×D435×H948×SH640 (mm)
[W18.5×D17.2×H37.4×SH25.2 (in.)]

maple	No.2E25-20	No.2E25-80	
ash	No.2E26-30	No.2E26-80	
oak	No.2F26-F0	No.2F26-80	No.2F26-K0
	No.2E27-20	No.2E27-30	No.2E27-80

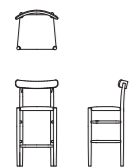











BAR STOOL Mid (cushioned)
W468×D435×H948×SH654 (mm)
[W18.5×D17.2×H37.4×SH25.8 (in.)]

maple	No.2631-20	No.2631-80	
ash	No.2471-30	No.2471-80	
oak	No.2F27-F0	No.2F27-80	No.2F27-K0
	No.2581-20	No.2581-30	No.2581-80

seat cover for BAR STOOL Mid & High

No.2571-90

Bar Stool High

maple	 clear (C-0)	 natural black (NK-1)	
ash	 whitish (NL-0)	 natural black (NK-1)	
oak	 bold whitish (NQ-0)	 bold black (BNK-1)	 bold charcoal (NU-0)
	 clear (C-0)	 whitish (NL-0)	 natural black (NK-1)

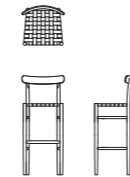

BAR STOOL High (webbing seat)
W468×D435×H1,093×SH782 (mm)
[W18.5×D17.2×H43.1×SH30.8 (in.)]

maple	No.2640-20	No.2640-80	
ash	No.2480-30	No.2480-80	
oak	No.2F28-F0	No.2F28-80	No.2F28-K0
	No.2690-20	No.2690-30	No.2690-80

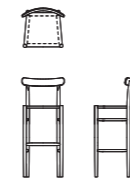

BAR STOOL High (mesh seat)
W468×D435×H1,093×SH782 (mm)
[W18.5×D17.2×H43.1×SH30.8 (in.)]

maple	No.2642-20	No.2642-80	
ash	No.2482-30	No.2482-80	
oak	No.2F29-F0	No.2F29-80	No.2F29-K0
	No.2692-20	No.2692-30	No.2692-80

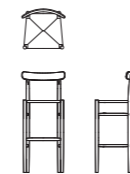

BAR STOOL High (paper cord)
W468×D435×H1,093×SH785 (mm)
[W18.5×D17.2×H43.1×SH31.0 (in.)]

maple	No.2E31-20	No.2E31-80	
ash	No.2E32-30	No.2E32-80	
oak	No.2F30-F0	No.2F30-80	No.2F30-K0
	No.2E33-20	No.2E33-30	No.2E33-80



BAR STOOL High (cushioned)
W468×D435×H1,093×SH799 (mm)
[W18.5×D17.2×H43.1×SH31.5 (in.)]

maple	No.2641-20	No.2641-80	
ash	No.2481-30	No.2481-80	
oak	No.2F31-F0	No.2F31-80	No.2F31-K0
	No.2691-20	No.2691-30	No.2691-80

seat cover for BAR STOOL Mid & High

No.2571-90

Stool Low	maple	 clear (C-0)	 natural black (NK-1)	
	ash	 whitish (NL-0)	 natural black (NK-1)	
	oak	 bold whitish (NQ-0)	 bold black (BNK-1)	 bold charcoal (NU-0)
		 clear (C-0)	 whitish (NL-0)	 natural black (NK-1)

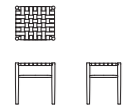

STOOL Low (webbing seat)
W435×D370×H453×SH450 (mm)
[W17.2×D14.6×H17.9×SH17.8 (in)]

maple	No.2534-20	No.2534-80	
ash	No.2424-30	No.2424-80	
oak	No.2F32-F0	No.2F32-80	No.2F32-K0
	No.2514-20	No.2514-30	No.2514-80

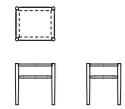

STOOL Low (mesh seat)
W435×D370×H453×SH450 (mm)
[W17.2×D14.6×H17.9×SH17.8 (in)]

maple	No.2536-20	No.2536-80	
ash	No.2426-30	No.2426-80	
oak	No.2F33-F0	No.2F33-80	No.2F33-K0
	No.2516-20	No.2516-30	No.2516-80

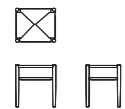

STOOL Low (paper cord)
W435×D370×H453×SH453 (mm)
[W17.2×D14.6×H17.9×SH17.9 (in)]

maple	No.2E22-20	No.2E22-80	
ash	No.2E23-30	No.2E23-80	
oak	No.2F34-F0	No.2F34-80	No.2F34-K0
	No.2E24-20	No.2E24-30	No.2E24-80

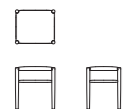

STOOL Low (cushioned)
W435×D370×H467×SH467 (mm)
[W17.2×D14.6×H18.4×SH18.4 (in)]

maple	No.2535-20	No.2535-80	
ash	No.2425-30	No.2425-80	
oak	No.2F35-F0	No.2F35-80	No.2F35-K0
	No.2515-20	No.2515-30	No.2515-80

seat cover for STOOL Low, Mid & High

No.2505-90

Stool Mid	maple	 clear (C-0)	 natural black (NK-1)	
	ash	 whitish (NL-0)	 natural black (NK-1)	
	oak	 bold whitish (NQ-0)	 bold black (BNK-1)	 bold charcoal (NU-0)
		 clear (C-0)	 whitish (NL-0)	 natural black (NK-1)

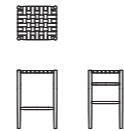

STOOL Mid (webbing seat)
W435×D370×H640×SH637 (mm)
[W17.2×D14.6×H25.2×SH25.1 (in)]

maple	No.2634-20	No.2634-80	
ash	No.2474-30	No.2474-80	
oak	No.2F36-F0	No.2F36-80	No.2F36-K0
	No.2584-20	No.2584-30	No.2584-80

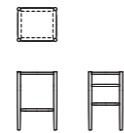

STOOL Mid (mesh seat)
W435×D370×H640×SH637 (mm)
[W17.2×D14.6×H25.2×SH25.1 (in)]

maple	No.2636-20	No.2636-80	
ash	No.2476-30	No.2476-80	
oak	No.2F37-F0	No.2F37-80	No.2F37-K0
	No.2586-20	No.2586-30	No.2586-80

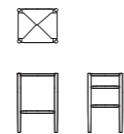

STOOL Mid (paper cord)
W435×D370×H640×SH640 (mm)
[W17.2×D14.6×H25.2×SH25.2 (in)]

maple	No.2E28-20	No.2E28-80	
ash	No.2E29-30	No.2E29-80	
oak	No.2F38-F0	No.2F38-80	No.2F38-K0
	No.2E30-20	No.2E30-30	No.2E30-80

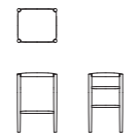





STOOL Mid (cushioned)
W435×D370×H654×SH654 (mm)
[W17.2×D14.6×H25.8×SH25.8 (in)]

maple	No.2635-20	No.2635-80	
ash	No.2475-30	No.2475-80	
oak	No.2F39-F0	No.2F39-80	No.2F39-K0
	No.2585-20	No.2585-30	No.2585-80

seat cover for STOOL Low, Mid & High

No.2505-90

Stool High

maple			
	clear (C-0)	natural black (NK-1)	
ash			
	whitish (NL-0)	natural black (NK-1)	
oak			
	bold whitish (NQ-0)	bold black (BNK-1)	bold charcoal (NU-0)
			
	clear (C-0)	whitish (NL-0)	natural black (NK-1)

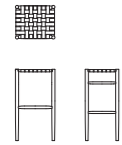

STOOL High (webbing seat)
W435×D370×H785×SH782 (mm)
[W17.2×D14.6×H31.0×SH30.8 (in)]

maple	No.2644-20	No.2644-80	
ash	No.2484-30	No.2484-80	
oak	No.2F40-F0	No.2F40-80	No.2F40-K0
	No.2694-20	No.2694-30	No.2694-80

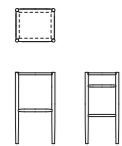

STOOL High (mesh seat)
W435×D370×H785×SH782 (mm)
[W17.2×D14.6×H31.0×SH30.8 (in)]

maple	No.2649-20	No.2649-80	
ash	No.2489-30	No.2489-80	
oak	No.2F41-F0	No.2F41-80	No.2F41-K0
	No.2696-20	No.2696-30	No.2696-80

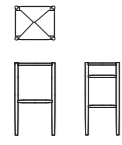

STOOL High (paper cord)
W435×D370×H785×SH785 (mm)
[W17.2×D14.6×H31.0×SH31.0 (in)]

maple	No.2E34-20	No.2E34-80	
ash	No.2E35-30	No.2E35-80	
oak	No.2F42-F0	No.2F42-80	No.2F42-K0
	No.2E36-20	No.2E36-30	No.2E36-80

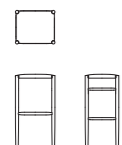





STOOL High (cushioned)
W435×D370×H799×SH799 (mm)
[W17.2×D14.6×H31.5×SH31.5 (in)]

maple	No.2647-20	No.2647-80	
ash	No.2487-30	No.2487-80	
oak	No.2F43-F0	No.2F43-80	No.2F43-K0
	No.2695-20	No.2695-30	No.2695-80

seat cover for STOOL Low, Mid & High

No.2505-90

Sofa

maple		
	clear (C-0)	
ash		
	whitish (NL-0)	
oak		
	bold whitish (NQ-0)	
		
	clear (C-0)	whitish (NL-0)

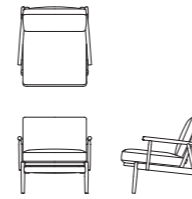

ARM SOFA
W734×D793×H758×SH440 (mm)
[W28.9×D31.3×H29.9×SH17.4 (in)]

maple	No.4E22-21	
ash	No.4E23-31	
oak	No.4E57-F1	
	No.4E39-21	No.4E39-31

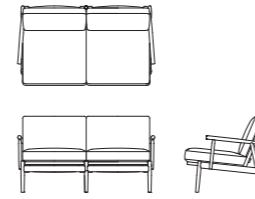

TWO SEATER SOFA
W1,367×D793×H758×SH440 (mm)
[W53.9×D31.3×H29.9×SH17.4 (in)]



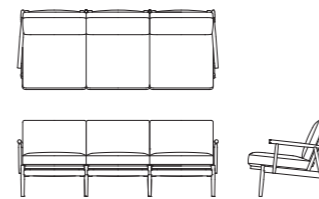

maple	No.4E22-22	
ash	No.4E23-32	
oak	No.4E57-F2	
	No.4E39-22	No.4E39-32



THREE SEATER SOFA
W2,000×D793×H758×SH440 (mm)
[W78.8×D31.3×H29.9×SH17.4 (in)]

maple	No.4E22-23	
ash	No.4E23-33	
oak	No.4E57-F3	
	No.4E39-23	No.4E39-33

Table

maple		clear (C-0)
ash		whitish (NL-0)
oak		bold whitish (NQ-0)
		clear (C-0)
		whitish (NL-0)

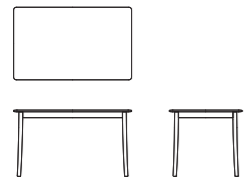

TABLE 130 (rectangular)
W1,300×D800×H730
intercrural width: 1,100 (mm)
[W51.2×D31.5×H28.8
intercrural width: 43.4 (in)]
Veneered Top

maple	No.1612-22	
ash	No.1422-32	
oak	No.1E87-F2	
	No.1512-22	No.1512-32

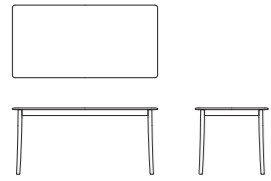

TABLE 160 (rectangular)
W1,600×D800×H730
intercrural width: 1,390 (mm)
[W63.0×D31.5×H28.8
intercrural width: 54.8 (in)]
Veneered Top

maple	No.1612-24	
ash	No.1422-34	
oak	No.1E87-F4	
	No.1512-24	No.1512-34

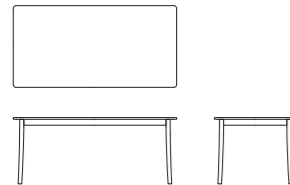

TABLE 180 (rectangular)
W1,800×D900×H730
intercrural width: 1,567 (mm)
[W70.9×D35.5×H28.8
intercrural width: 61.7 (in)]
Veneered Top

maple	No.1612-25	
ash	No.1422-35	
oak	No.1E87-F5	
	No.1512-25	No.1512-35

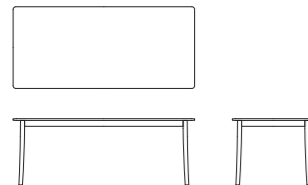

TABLE 200 (rectangular)
W2,000×D900×H730
intercrural width: 1,747 (mm)
[W78.8×D35.5×H28.8
intercrural width: 68.8 (in)]
Veneered Top

maple	No.1612-26	
ash	No.1422-36	
oak	No.1E87-F6	
	No.1512-26	No.1512-36

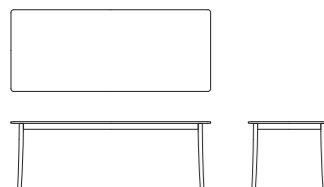

TABLE 220 (rectangular)
W2,200×D900×H730
intercrural width: 1,927 (mm)
[W86.7×D35.5×H28.8
intercrural width: 75.9 (in)]
Veneered Top

maple	No.1612-27	
ash	No.1422-37	
oak	No.1E87-F7	
	No.1512-27	No.1512-37

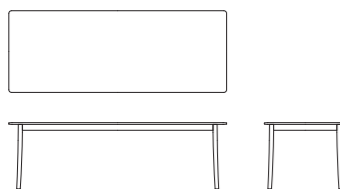







TABLE 240 (rectangular)
W2,400×D900×H730
intercrural width: 2,100 (mm)
[W94.5×D35.5×H28.8
intercrural width: 82.7 (in)]
Veneered Top

maple	No.1612-28	
ash	No.1422-38	
oak	No.1E87-F8	
	No.1512-28	No.1512-38

Table (corian® top)

maple		clear (C-0)
ash		whitish (NL-0)
oak		bold whitish (NQ-0)
		clear (C-0)
		whitish (NL-0)

DuPont™ corian®
cameo white

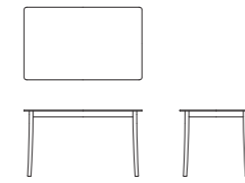

TABLE 130 (rectangular)
W1,300×D800×H730
intercrural width: 1,100 (mm)
[W51.2×D31.5×H28.8
intercrural width: 43.4 (in)]
corian® Top

maple	No.1611-22	
ash	No.1421-32	
oak	No.1E88-F2	
	No.1511-22	No.1511-32

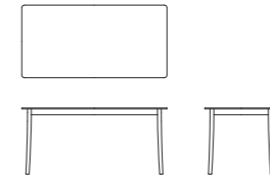

TABLE 160 (rectangular)
W1,600×D800×H730
intercrural width: 1,390 (mm)
[W63.0×D31.5×H28.8
intercrural width: 54.8 (in)]
corian® Top

maple	No.1611-24	
ash	No.1421-34	
oak	No.1E88-F4	
	No.1511-24	No.1511-34

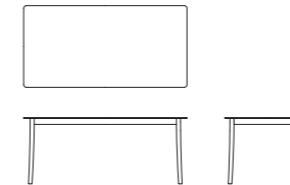

TABLE 180 (rectangular)
W1,800×D900×H730
intercrural width: 1,567 (mm)
[W70.9×D35.5×H28.8
intercrural width: 61.7 (in)]
corian® Top

maple	No.1611-25	
ash	No.1421-35	
oak	No.1E88-F5	
	No.1511-25	No.1511-35

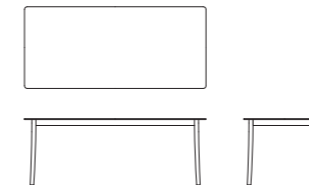

TABLE 200 (rectangular)
W2,000×D900×H730
intercrural width: 1,747 (mm)
[W78.8×D35.5×H28.8
intercrural width: 68.8 (in)]
corian® Top

maple	No.1611-26	
ash	No.1421-36	
oak	No.1E88-F6	
	No.1511-26	No.1511-36

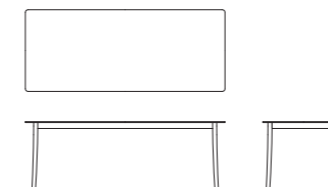

TABLE 220 (rectangular)
W2,200×D900×H730
intercrural width: 1,927 (mm)
[W86.7×D35.5×H28.8
intercrural width: 75.9 (in)]
corian® Top

maple	No.1611-27	
ash	No.1421-37	
oak	No.1E88-F7	
	No.1511-27	No.1511-37

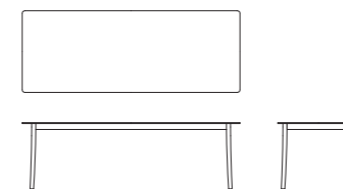







TABLE 240 (rectangular)
W2,400×D900×H730
intercrural width: 2,100 (mm)
[W94.5×D35.5×H28.8
intercrural width: 82.7 (in)]
corian® Top

maple	No.1611-28	
ash	No.1421-38	
oak	No.1E88-F8	
	No.1511-28	No.1511-38

Desk

maple		clear (C-0)
ash		whitish (NL-0)
oak		bold whitish (NQ-0)
		clear (C-0)
		whitish (NL-0)

maple	No.6E03-24	
ash	No.6E04-34	
oak	No.6E16-F4	
	No.6E05-24	No.6E05-34

maple	No.6E03-24 -0073	
ash	No.6E04-34 -0073	
oak	No.6E16-F4 -0073	
	No.6E05-24 -0073	No.6E05-34 -0073

maple	No.6E06-24	
ash	No.6E07-34	
oak	No.6E17-F4	
	No.6E08-24	No.6E08-34

maple	No.6E06-24 -0080	
ash	No.6E07-34 -0080	
oak	No.6E17-F4 -0080	
	No.6E08-24 -0080	No.6E08-34 -0080

DESK 120 Low
W1,200×D500×H710 (mm)
[W47.3×D19.7×H28.0 (in)]
Solid Wood Top

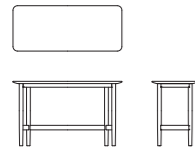

DESK 120 High
W1,200×D500×H730 (mm)
[W47.3×D19.7×H28.8 (in)]
Solid Wood Top

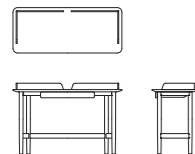

DESK 120 (with panel and drawer) Low
W1,200×D500×H780 (mm)
[W47.3×D19.7×H30.8 (in)]
Solid Wood Top

DESK 120 (with panel and drawer) High
W1,200×D500×H800 (mm)
[W47.3×D19.7×H31.5 (in)]
Solid Wood Top

corian®



DuPont™
corian®
cameo white

maple



urethane finish, clear (C-0) urethane finish, natural black (NK-1)

ash



urethane finish, whitish (NL-0) urethane finish, natural black (NK-1)























































































oak



urethane finish, bold whitish (NQ-0) urethane finish, bold black (BNK-1) urethane finish, bold charcoal (NU-0)



















urethane finish, clear (C-0) urethane finish, whitish (NL-0) urethane finish, natural black (NK-1)

M-01	TWILL										
		#4586	#4570	#4580	#4583	#4573	#4581	#4571	#4588	#4589	
M-02	Remix										
		#3317	#3310	#3313	#3311	#3314	#3318	#3E01	#3319	#3E02	#3329
	SAGA										
		#4162	#4160	#4163	#4167	#4169					
	MAYA										
		#3575	#3579	#3572	#3576	#3570	#3578	#3589			
	Livorno										
		#3E03	#3E04	#3E05	#3E06						
M-03	BAROJA										
		#3E07	#3E08	#3E09	#3E10	#3E11					
	Merit										
		#2E02	#2E03	#2E04	#2E05	#2E06					
M-04	Melange Nap										
		#4136	#4E19	#4133	#4E20	#4E21	#4137	#4129			
	Quay										
		#4E11	#4E12	#4E13	#4E14	#4E15	#4E16	#4E17	#4E18		
M-05	Divina MD										
		#4725	#4722	#4720	#4721	#4724	#4729	#4719			
	Tonus										
		#4E08									
M-06	Hallingdal										
		#2E08	#2936	#2932	#2E09	#2930	#2934	#2E07	#2949	#2939	#2E10
L-01	leather										
		#5191									
	tanned leather *1										
		#5006									
L-02	elmosoft										
		#5025	#5035	#5022	#5032	#5037	#5020	#5024			

*1 Tanned leather is not available for sofas.

webbing					
	#0880	#0892	#0890	#0894	#0898
mesh					
	#0905				
paper cord					
	#0E00				

Chair	maple		clear (C-0)		natural black (NK-1)							
	ash		whitish (NL-0)		natural black (NK-1)							
	oak		bold whitish (NQ-0)		bold black (BNK-1)							
					bold charcoal (NU-0)							
oak		clear (C-0)		natural black (NK-1)								
		whitish (NL-0)										
steel		black		green		red		silver		black		silver

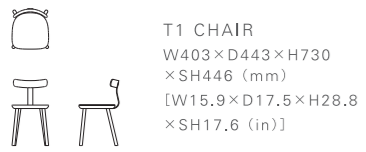

T1 CHAIR
W403×D443×H730
×SH446 (mm)
[W15.9×D17.5×H28.8
×SH17.6 (in)]







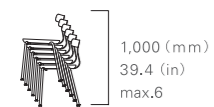







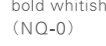

maple	No.2670-22	No.2670-23	No.2670-24	No.2670-26	No.2670-82	No.2670-86
ash	No.2680-32	No.2680-33	No.2680-34	No.2680-36	No.2680-82	No.2680-86
oak	No.2F44-F2	No.2F44-F3	No.2F44-F4	No.2F44-F6	No.2F44-K2	No.2F44-K6
	No.2520-22	No.2520-23	No.2520-24	No.2520-26	No.2520-82	No.2520-86
	No.2520-32	No.2520-33	No.2520-34	No.2520-36		



T1 CHAIR STACKABLE
W490×D446×H730
×SH446 (mm)
[W19.3×D17.6×H28.8
×SH17.6 (in)]



maple	No.2E04-22	No.2E04-23	No.2E04-24	No.2E04-26	No.2E04-82	No.2E04-86
ash	No.2E06-32	No.2E06-33	No.2E06-34	No.2E06-36	No.2E06-82	No.2E06-86
oak	No.2F45-F2	No.2F45-F3	No.2F45-F4	No.2F45-F6	No.2F45-K2	No.2F45-K6
	No.2E05-22	No.2E05-23	No.2E05-24	No.2E05-26	No.2E05-82	No.2E05-86
	No.2E05-32	No.2E05-33	No.2E05-34	No.2E05-36		



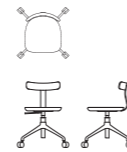













Chair	maple		clear (C-0)		natural black (NK-1)							
	ash		whitish (NL-0)		natural black (NK-1)							
	oak		bold whitish (NQ-0)		bold black (BNK-1)							
					bold charcoal (NU-0)							
oak		clear (C-0)		natural black (NK-1)								
		whitish (NL-0)										
steel		black		green		red		silver		black		silver



T1 TASK CHAIR
W567×D567×H725-838
SH442-555 (mm)
[W22.4×D22.4×H28.6-33.0
SH17.5-21.9 (in)]
Base is made of aluminum.

maple	No.2E77-22				No.2E77-82	
ash	No.2E78-32				No.2E78-82	
oak	No.2F46-F2				No.2F46-K2	
	No.2E79-22				No.2E79-82	
	No.2E79-32					

Bar Stool Mid • Bar Stool High







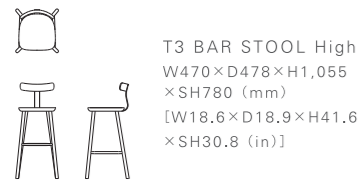
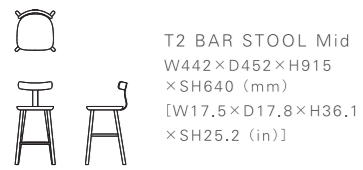





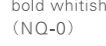

maple		clear (C-0)		natural black (NK-1)		
		whitish (NL-0)		natural black (NK-1)		
oak		bold whitish (NQ-0)		bold black (BNK-1)		
				bold charcoal (NU-0)		
		clear (C-0)		natural black (NK-1)		
		whitish (NL-0)				
steel						
	black	green	red	silver	black	silver

maple	No.2672-22	No.2672-23	No.2672-24	No.2672-26	No.2672-82	No.2672-86
ash	No.2682-32	No.2682-33	No.2682-34	No.2682-36	No.2682-82	No.2682-86
oak	No.2F47-F2	No.2F47-F3	No.2F47-F4	No.2F47-F6	No.2F47-82	No.2F47-86
					No.2F47-K2	No.2F47-K6
	No.2522-22	No.2522-23	No.2522-24	No.2522-26	No.2522-82	No.2522-86
	No.2522-32	No.2522-33	No.2522-34	No.2522-36		

maple	No.2677-22	No.2677-23	No.2677-24	No.2677-26	No.2677-82	No.2677-86
ash	No.2687-32	No.2687-33	No.2687-34	No.2687-36	No.2687-82	No.2687-86
oak	No.2F48-F2	No.2F48-F3	No.2F48-F4	No.2F48-F6	No.2F48-82	No.2F48-86
					No.2F48-K2	No.2F48-K6
	No.2527-22	No.2527-23	No.2527-24	No.2527-26	No.2527-82	No.2527-86
	No.2527-32	No.2527-33	No.2527-34	No.2527-36		



Stool Low • Stool Mid







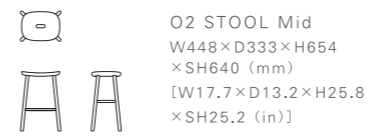
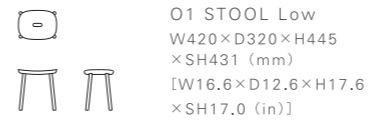









maple		clear (C-0)		natural black (NK-1)		
		whitish (NL-0)		natural black (NK-1)		
oak		bold whitish (NQ-0)		bold black (BNK-1)		
				bold charcoal (NU-0)		
		clear (C-0)		natural black (NK-1)		
		whitish (NL-0)				
steel						
	black	green	red	silver	black	silver

maple	No.2850-20	No.2850-80
ash	No.2860-30	No.2860-80
oak	No.2F49-F0	No.2F49-80
		No.2F49-K0
	No.2870-20	No.2870-80
	No.2870-30	

maple	No.2852-22	No.2852-23	No.2852-24	No.2852-26	No.2852-82	No.2852-86
ash	No.2862-32	No.2862-33	No.2862-34	No.2862-36	No.2862-82	No.2862-86
oak	No.2F50-F2	No.2F50-F3	No.2F50-F4	No.2F50-F6	No.2F50-82	No.2F50-86
					No.2F50-K2	No.2F50-K6
	No.2872-22	No.2872-23	No.2872-24	No.2872-26	No.2872-82	No.2872-86
	No.2872-32	No.2872-33	No.2872-34	No.2872-36		









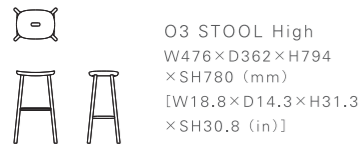

Stool High

maple		clear (C-0)		natural black (NK-1)
		whitish (NL-0)		natural black (NK-1)
oak		bold whitish (NQ-0)		bold black (BNK-1)
		bold charcoal (NU-0)		bold charcoal (NU-0)
		clear (C-0)		natural black (NK-1)
		whitish (NL-0)		
steel		black		green
		red		silver
		black		silver

maple	No.2857-22	No.2857-23	No.2857-24	No.2857-26	No.2857-82	No.2857-86
ash	No.2868-32	No.2868-33	No.2868-34	No.2868-36	No.2868-82	No.2868-86
oak	No.2F51-F2	No.2F51-F3	No.2F51-F4	No.2F51-F6	No.2F51-82	No.2F51-86
					No.2F51-K2	No.2F51-K6
	No.2877-22	No.2877-23	No.2877-24	No.2877-26	No.2877-82	No.2877-86



Table

maple		clear (C-0)
		whitish (NL-0)
oak		bold whitish (NQ-0)
		clear (C-0)
		whitish (NL-0)
steel		black
		green
		red
		silver









maple	No.1574-92-0702	No.1574-92-0703	No.1574-92-0704	No.1574-92-0706
ash	No.1634-93-0702	No.1634-93-0703	No.1634-93-0704	No.1634-93-0706
oak	No.1E92-9F-0702	No.1E92-9F-0703	No.1E92-9F-0704	No.1E92-9F-0706
	No.1534-92-0702	No.1534-92-0703	No.1534-92-0704	No.1534-92-0706
	No.1534-93-0702	No.1534-93-0703	No.1534-93-0704	No.1534-93-0706
maple	No.1570-92-0632	No.1570-92-0633	No.1570-92-0634	No.1570-92-0636
ash	No.1630-93-0632	No.1630-93-0633	No.1630-93-0634	No.1630-93-0636
oak	No.1E89-9F-0632	No.1E89-9F-0633	No.1E89-9F-0634	No.1E89-9F-0636
	No.1530-92-0632	No.1530-92-0633	No.1530-92-0634	No.1530-92-0636
	No.1530-93-0632	No.1530-93-0633	No.1530-93-0634	No.1530-93-0636



TABLE 70 (rectangular)
W700×D650×H720 (mm)
[W27.6×D25.6×H28.4 (in)]
Veneered Top



ROUND TABLE 63
Φ625×H720 (mm)
[Φ24.7×H28.4 (in)]
Veneered Top





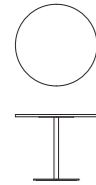



Table	maple		clear (C-0)
	ash		whitish (NL-0)
	oak		bold whitish (NQ-0)
			clear (C-0)
	steel	   	black green red silver

ROUND TABLE 90
 Ø900×H725 (mm)
 [Ø35.5×H28.6 (in)]
 Veneered Top



ROUND TABLE 90
 Ø900×H725 (mm)
 [Ø35.5×H28.6 (in)]
 Solid Wood Top

maple	No.1572-92-0902	No.1572-92-0903	No.1572-92-0904	No.1572-92-0906
ash	No.1632-93-0902	No.1632-93-0903	No.1632-93-0904	No.1632-93-0906
oak	No.1E90-9F-0902	No.1E90-9F-0903	No.1E90-9F-0904	No.1E90-9F-0906
	No.1532-92-0902	No.1532-92-0903	No.1532-92-0904	No.1532-92-0906
	No.1532-93-0902	No.1532-93-0903	No.1532-93-0904	No.1532-93-0906
maple	No.1573-92-0902	No.1573-92-0903	No.1573-92-0904	No.1573-92-0906
ash	No.1633-93-0902	No.1633-93-0903	No.1633-93-0904	No.1633-93-0906
oak	No.1E91-9F-0902	No.1E91-9F-0903	No.1E91-9F-0904	No.1E91-9F-0906
	No.1533-92-0902	No.1533-92-0903	No.1533-92-0904	No.1533-92-0906
	No.1533-93-0902	No.1533-93-0903	No.1533-93-0904	No.1533-93-0906







Table	maple		clear (C-0)
	ash		whitish (NL-0)
	oak		bold whitish (NQ-0)
			clear (C-0)
	steel	   	black green red silver

ROUND BAR TABLE 63
 Ø625×H1,100 (mm)
 [Ø24.7×H43.4 (in)]
 Veneered Top



maple	No.1551-92-0632	No.1551-92-0633	No.1551-92-0634	No.1551-92-0636
ash	No.1621-93-0632	No.1621-93-0633	No.1621-93-0634	No.1621-93-0636
oak	No.1E93-9F-0632	No.1E93-9F-0633	No.1E93-9F-0634	No.1E93-9F-0636
	No.1541-92-0632	No.1541-92-0633	No.1541-92-0634	No.1541-92-0636
	No.1541-93-0632	No.1541-93-0633	No.1541-93-0634	No.1541-93-0636

Table

maple		clear (C-0)
ash		whitish (NL-0)
oak		bold whitish (NQ-0)
		clear (C-0)
		whitish (NL-0)
steel		black green red silver

COFFEE TABLE 90
 Ø900×H450 (mm)
 [Ø35.5×H17.8 (in)]
 Veneered Top

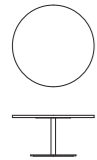

COFFEE TABLE 90
 Ø900×H450 (mm)
 [Ø35.5×H17.8 (in)]
 Solid Wood Top

maple	No.3572-22	No.3572-23	No.3572-24	No.3572-26
ash	No.3682-32	No.3682-33	No.3682-34	No.3682-36
oak	No.3E48-F2	No.3E48-F3	No.3E48-F4	No.3E48-F6
	No.3532-22	No.3532-23	No.3532-24	No.3532-26
	No.3532-32	No.3532-33	No.3532-34	No.3532-36
maple	No.3573-22	No.3573-23	No.3573-24	No.3573-26
ash	No.3683-32	No.3683-33	No.3683-34	No.3683-36
oak	No.3E49-F2	No.3E49-F3	No.3E49-F4	No.3E49-F6
	No.3533-22	No.3533-23	No.3533-24	No.3533-26
	No.3533-32	No.3533-33	No.3533-34	No.3533-36

Table







maple		clear (C-0)
ash		whitish (NL-0)
oak		bold whitish (NQ-0)
		clear (C-0)
		whitish (NL-0)
steel		black green red silver

TABLE 180 (rectangular)
 W1,800×D800×H725
 intercrural width:1,000 (mm)
 [W70.9×D31.5×H28.6
 intercrural width:39.4 (in)]
 Veneered Top

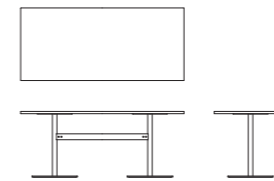

TABLE 180 (rectangular)
 W1,800×D800×H725
 intercrural width:1,000 (mm)
 [W70.9×D31.5×H28.6
 intercrural width:39.4 (in)]
 Solid Wood Top

maple	No.1576-92 -1802	No.1576-92 -1803	No.1576-92 -1804	No.1576-92 -1806
ash	No.1636-93 -1802	No.1636-93 -1803	No.1636-93 -1804	No.1636-93 -1806
oak	No.1E94-9F -1802	No.1E94-9F -1803	No.1E94-9F -1804	No.1E94-9F -1806
	No.1536-92 -1802	No.1536-92 -1803	No.1536-92 -1804	No.1536-92 -1806
	No.1536-93 -1802	No.1536-93 -1803	No.1536-93 -1804	No.1536-93 -1806
maple	No.1577-92 -1802	No.1577-92 -1803	No.1577-92 -1804	No.1577-92 -1806
ash	No.1637-93 -1802	No.1637-93 -1803	No.1637-93 -1804	No.1637-93 -1806
oak	No.1E95-9F 1802	No.1E95-9F -1803	No.1E95-9F -1804	No.1E95-9F -1806
	No.1537-92 1802	No.1537-92 -1803	No.1537-92 -1804	No.1537-92 -1806
	No.1537-93 -1802	No.1537-93 -1803	No.1537-93 -1804	No.1537-93 -1806

Table









maple		clear (C-0)
ash		whitish (NL-0)
oak		bold whitish (NQ-0)
		clear (C-0)
		whitish (NL-0)
steel	   	black green red silver

TABLE 200 (rectangular)
W2,000×D800×H725
intercrural width: 1,150 (mm)
[W78.8×D31.5×H28.6
intercrural width: 45.3 (in)]
Veneered Top

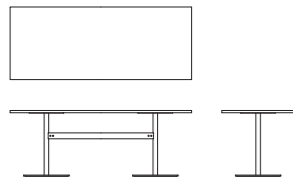

TABLE 200 (rectangular)
W2,000×D800×H725
intercrural width: 1,150 (mm)
[W78.8×D31.5×H28.6
intercrural width: 45.3 (in)]
Solid Wood Top

maple	No.1576-92 -2002	No.1576-92 -2003	No.1576-92 -2004	No.1576-92 -2006
ash	No.1636-93 -2002	No.1636-93 -2003	No.1636-93 -2004	No.1636-93 -2006
oak	No.1E94-9F -2002	No.1E94-9F -2003	No.1E94-9F -2004	No.1E94-9F -2006
	No.1536-92 -2002	No.1536-92 -2003	No.1536-92 -2004	No.1536-92 -2006
	No.1536-93 -2002	No.1536-93 -2003	No.1536-93 -2004	No.1536-93 -2006
maple	No.1577-92 -2002	No.1577-92 -2003	No.1577-92 -2004	No.1577-92 -2006
ash	No.1637-93 -2002	No.1637-93 -2003	No.1637-93 -2004	No.1637-93 -2006
oak	No.1E95-9F -2002	No.1E95-9F -2003	No.1E95-9F -2004	No.1E95-9F -2006
	No.1537-92 -2002	No.1537-92 -2003	No.1537-92 -2004	No.1537-92 -2006
	No.1537-93 -2002	No.1537-93 -2003	No.1537-93 -2004	No.1537-93 -2006

Table









maple		clear (C-0)
ash		whitish (NL-0)
oak		bold whitish (NQ-0)
		clear (C-0)
		whitish (NL-0)
steel	   	black green red silver

TABLE 240 (rectangular)
W2,400×D900×H725
intercrural width: 1,450 (mm)
[W94.5×D35.5×H28.6
intercrural width: 57.1 (in)]
Veneered Top

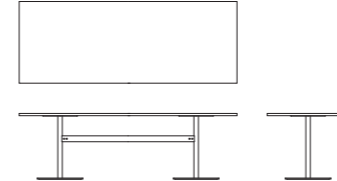

TABLE 240 (rectangular)
W2,400×D900×H725
intercrural width: 1,450 (mm)
[W94.5×D35.5×H28.6
intercrural width: 57.1 (in)]
Solid Wood Top

maple	No.1576-92 -2402	No.1576-92 -2403	No.1576-92 -2404	No.1576-92 -2406
ash	No.1636-93 -2402	No.1636-93 -2403	No.1636-93 -2404	No.1636-93 -2406
oak	No.1E94-9F -2402	No.1E94-9F -2403	No.1E94-9F -2404	No.1E94-9F -2406
	No.1536-92 -2402	No.1536-92 -2403	No.1536-92 -2404	No.1536-92 -2406
	No.1536-93 -2402	No.1536-93 -2403	No.1536-93 -2404	No.1536-93 -2406
maple	No.1577-92 -2402	No.1577-92 -2403	No.1577-92 -2404	No.1577-92 -2406
ash	No.1637-93 -2402	No.1637-93 -2403	No.1637-93 -2404	No.1637-93 -2406
oak	No.1E95-9F -2402	No.1E95-9F -2403	No.1E95-9F -2404	No.1E95-9F -2406
	No.1537-92 -2402	No.1537-92 -2403	No.1537-92 -2404	No.1537-92 -2406
	No.1537-93 -2402	No.1537-93 -2403	No.1537-93 -2404	No.1537-93 -2406

maple



urethane finish, clear (C-0) urethane finish, natural black (NK-1)

ash



urethane finish, whitish (NL-0) urethane finish, natural black (NK-1)

oak

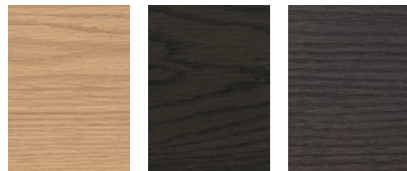

urethane finish, bold whitish (NQ-0) urethane finish, bold black (BNK-1) urethane finish, bold charcoal (NU-0)



urethane finish, clear (C-0) urethane finish, whitish (NL-0) urethane finish, natural black (NK-1)

steel



black powder coated green powder coated red powder coated silver powder coated

aluminum



black powder coated
*for T1 TASK CHAIR base

Chair



CHAIR
W468×D530×H787×SH445 (mm)
[W18.5×D20.9×H31.0×SH17.6 (in)]

ash			
	whitish (NL-0)	natural black (NK-1)	
oak			
	bold whitish (NQ-0)	bold black (BNK-1)	bold charcoal (NU-0)
	clear (C-0)	whitish (NL-0)	natural black (NK-1)

ash	No.2466-30	No.2466-80	
oak	No.2F52-F0	No.2F52-80	No.2F52-K0
	No.2416-20	No.2416-30	No.2416-80

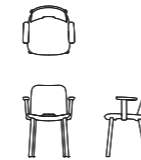

ARMCHAIR
W566×D530×H787×SH445
arm height : 656 (mm)
[W22.3×D20.9×H31.0×SH17.6
arm height : 25.9 (in)]

ash	No.2466-31	No.2466-81	
oak	No.2F52-F1	No.2F52-81	No.2F52-K1
	No.2416-21	No.2416-31	No.2416-81

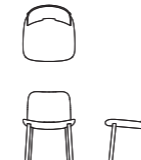

LOBBY CHAIR (armless)
W550×D596×H735×SH410 (mm)
[W21.7×D23.5×H29.0×SH16.2 (in)]

ash	No.4336-30	No.4336-80	
oak	No.4E58-F0	No.4E58-80	No.4E58-K0
	No.4306-20	No.4306-30	No.4306-80



LOBBY CHAIR (with armrests)
W580×D596×H735×SH410
arm height : 606 (mm)
[W22.9×D23.5×H29.0×SH16.2
arm height : 23.9 (in)]

ash	No.4336-31	No.4336-81	
oak	No.4E58-F1	No.4E58-81	No.4E58-K1
	No.4306-21	No.4306-31	No.4306-81



LOUNGE CHAIR (armless)
W585×D642×H704×SH391 (mm)
[W23.1×D25.3×H27.8×SH15.4 (in)]

ash	No.4466-30	No.4466-80	
oak	No.4E59-F0	No.4E59-80	No.4E59-K0
	No.4416-20	No.4416-30	No.4416-80

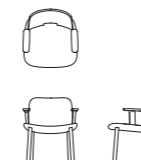

LOUNGE CHAIR (with armrests)
W604×D642×H704×SH391
arm height : 583 (mm)
[W23.8×D25.3×H27.8×SH15.4
arm height : 23.0 (in)]

ash	No.4466-31	No.4466-81	
oak	No.4E59-F1	No.4E59-81	No.4E59-K1
	No.4416-21	No.4416-31	No.4416-81

Table

ash			
oak			

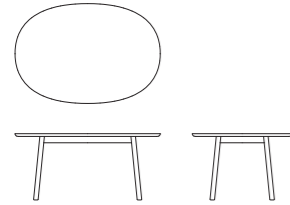

TABLE 160 (oval)
W1,600×D1,100×H730
intercrural width: 967 (mm)
[W63.0×D43.4×H28.8
intercrural width: 38.1 (in)]
Solid Wood Top

ash	No.1E01-34		
oak	No.1E96-F4		
	No.1E00-24	No.1E00-34	No.1E00-44

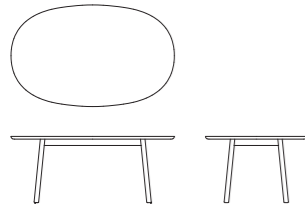

TABLE 180 (oval)
W1,800×D1,120×H730
intercrural width: 1,067 (mm)
[W70.9×D44.1×H28.8
intercrural width: 42.1 (in)]
Solid Wood Top

ash	No.1E01-35		
oak	No.1E96-F5		
	No.1E00-25	No.1E00-35	No.1E00-45

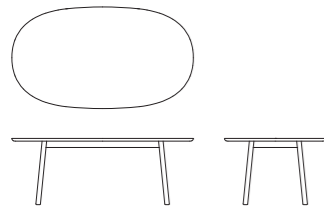

TABLE 200 (oval)
W2,000×D1,120×H730
intercrural width: 1,247 (mm)
[W78.8×D44.1×H28.8
intercrural width: 49.1 (in)]
Solid Wood Top

ash	No.1E01-36		
oak	No.1E96-F6		
	No.1E00-26	No.1E00-36	No.1E00-46

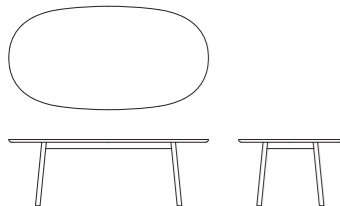

TABLE 220 (oval)
W2,200×D1,140×H730
intercrural width: 1,387 (mm)
[W86.7×D44.9×H28.8
intercrural width: 54.7 (in)]
Solid Wood Top

ash	No.1E01-37		
oak	No.1E96-F7		
	No.1E00-27	No.1E00-37	No.1E00-47

Table

ash			
oak			



COFFEE TABLE 80
Φ800×H400 (mm)
[Φ31.5×H15.8 (in)]
Solid Wood Top

ash	No.3336-31		
oak	No.3E50-F1		
	No.3306-21	No.3306-31	No.3306-41



COFFEE TABLE 100
Φ1,000×H400 (mm)
[Φ39.4×H15.8 (in)]
Solid Wood Top

ash	No.3336-32		
oak	No.3E50-F2		
	No.3306-22	No.3306-32	No.3306-42

ash



urethane finish, whitish (NL-0) urethane finish, natural black (NK-1)

oak



urethane finish, bold whitish (NQ-0) urethane finish, bold black (BNK-1) urethane finish, bold charcoal (NU-0)



urethane finish, clear (C-0) urethane finish, whitish (NL-0) urethane finish, natural black (NK-1) oil finish, clear (NB-1)

Chair • Table

	maple						
	CHAIR (wooden seat) W507×D486×H733×SH455 (mm) [W20.0×D19.2×H28.9×SH17.8 (in)]	maple	No.2E19-20	No.2E19-80	No.2E19-60	No.2E19-50	No.2E19-40
			Available in all fabrics.			Available only in a specific fabric.	
	CHAIR (cushioned) W507×D486×H733×SH455 (mm) [W20.0×D19.2×H28.9×SH18.0 (in)]	maple	No.2E11-20	No.2E11-80	No.2E11-60	No.2E11-50 #2E08 fabric M-05 Hallingdal beige	No.2E11-40 #4E08 fabric M-05 Tonus orange brown
	seat cover for CHAIR		No.2E11-90 Available only in fabrics.			No.2E11-90 #2E08	No.2E11-90 #4E08
		maple (top)					
	top leg	maple (leg)					
	ROUND TABLE 125 Φ1,250×H725 (mm) [Φ49.3×H28.6 (in)] Solid Wood Top	maple	No.1E06-22	No.1E06-82	No.1E06-62	No.1E06-52	No.1E06-42
	ROUND TABLE 140 Φ1,400×H725 (mm) [Φ55.2×H28.6 (in)] Solid Wood Top	maple	No.1E06-23	No.1E06-83	No.1E06-63	No.1E06-53	No.1E06-43

maple



urethane finish, clear (C-0) urethane finish, matte black (EC-0) urethane finish, matte clay white (EN-0) urethane finish, matte dusty green (EO-0) urethane finish, matte rusty red (EP-0)













M-01	TWILL		#4586 #4570 #4580 #4583 #4573 #4581 #4571 #4588 #4589	
M-02	Remix		#3317 #3310 #3313 #3311 #3314 #3318 #3E01 #3319 #3E02 #3329	
	SAGA	not available		
	MAYA		#3575 #3579 #3572 #3576 #3570 #3578 #3589	
	Livorno		#3E03 #3E04 #3E05 #3E06	
M-03	BAROJA	not available		
	Merit		#2E02 #2E03 #2E04 #2E05 #2E06	
M-04	Melange Nap		#4136 #4E19 #4133 #4E20 #4E21 #4137 #4129	
	Quay		#4E11 #4E12 #4E13 #4E14 #4E15 #4E16 #4E17 #4E18	
M-05	Divina MD		#4725 #4722 #4720 #4721 #4724 #4729 #4719	
	Tonus		#4E08	
M-06	Hallingdal		#2E08 #2936 #2932 #2E09 #2930 #2934 #2E07 #2949 #2939 #2E10	
L-01	leather		#5191	
	tanned leather		#5006	
L-02	elmosoft		#5025 #5035 #5022 #5032 #5037 #5020 #5024	

* EN CHAIR (cushioned) in matte dusty green (EO-0) and in matte rusty red (EP-0) are available only in specific fabrics.

Stool	maple		clear (C-0)		matte clay white (EN-0)			
	ash		whitish (NL-0)		natural black (NK-1)			
	oak		bold clear (BC-0)		bold whitish (NQ-0)		bold black (BNK-1)	
			clear (C-0)		whitish (NL-0)		natural black (NK-1)	
	walnut		clear (C-0)		light brown (WB-1)			
 	maple	No.2E69-26	No.2E69-66					
	ash	No.2E70-36	No.2E70-86					
	oak	No.2F53-26	No.2F53-F6	No.2F53-86	No.2F53-K6			
		No.2E71-26	No.2E71-36	No.2E71-86				
	walnut	No.2E72-66	No.2E72-26					
 	maple	No.2E73-26	No.2E73-66					
	ash	No.2E74-36	No.2E74-86					
	oak	No.2F54-26	No.2F54-F6	No.2F54-86	No.2F54-K6			
		No.2E75-26	No.2E75-36	No.2E75-86				
	walnut	No.2E76-66	No.2E76-26					

STOOL Mid
W448×D353×H630 (mm)
[W17.7×D13.9×H24.9 (in)]
Steel Base

STOOL High
W448×D353×H730 (mm)
[W17.7×D13.9×H28.8 (in)]
Steel Base

Table	maple	 clear (C-0)	 matte clay white (EN-0)			
	ash	 whitish (NL-0)	 natural black (NK-1)			
	oak	 bold clear (BC-0)	 bold whitish (NQ-0)	 bold black (BNK-1)	 bold charcoal (NU-0)	
		 clear (C-0)	 whitish (NL-0)	 natural black (NK-1)		
walnut	 clear (C-0)	 light brown (WB-1)				

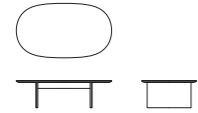

COFFEE TABLE 105 (oval)
W1,050×D600×H300 (mm)
[W41.4×D23.7×H11.9 (in)]
Solid Wood Top

maple	No.3E00-23	No.3E00-63		
ash	No.3E01-33	No.3E01-83		
oak	No.3E51-23	No.3E51-F3	No.3E51-83	No.3E51-K3
	No.3E02-23	No.3E02-33	No.3E02-83	
walnut	No.3E03-63	No.3E03-23		

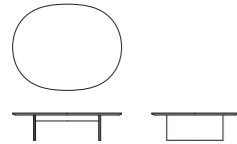





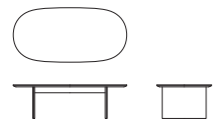







COFFEE TABLE 120 (oval)
W1,200×D950×H300 (mm)
[W47.3×D37.5×H11.9 (in)]
Solid Wood Top

maple	No.3E00-24	No.3E00-64		
ash	No.3E01-34	No.3E01-84		
oak	No.3E51-24	No.3E51-F4	No.3E51-84	No.3E51-K4
	No.3E02-24	No.3E02-34	No.3E02-84	
walnut	No.3E03-64	No.3E03-24		



COFFEE TABLE 125 (oval)
W1,250×D600×H370 (mm)
[49.3×D23.7×H14.6 (in)]
Solid Wood Top

maple	No.3E00-25	No.3E00-65		
ash	No.3E01-35	No.3E01-85		
oak	No.3E51-25	No.3E51-F5	No.3E51-85	No.3E51-K5
	No.3E02-25	No.3E02-35	No.3E02-85	
walnut	No.3E03-65	No.3E03-25		

Table	maple	 clear (C-0)	 matte clay white (EN-0)			
	ash	 whitish (NL-0)	 natural black (NK-1)			
	oak	 bold clear (BC-0)	 bold whitish (NQ-0)	 bold black (BNK-1)	 bold charcoal (NU-0)	
		 clear (C-0)	 whitish (NL-0)	 natural black (NK-1)		
walnut	 clear (C-0)	 light brown (WB-1)				

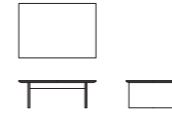

COFFEE TABLE 85 (rectangular)
W850×D600×H300 (mm)
[W33.5×D23.7×H11.9 (in)]
Solid Wood Top

maple	No.3E04-21	No.3E04-61		
ash	No.3E05-31	No.3E05-81		
oak	No.3E52-21	No.3E52-F1	No.3E52-81	No.3E52-K1
	No.3E06-21	No.3E06-31	No.3E06-81	
walnut	No.3E07-61	No.3E07-21		

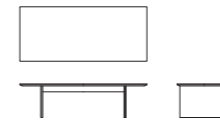











COFFEE TABLE 140 (rectangular)
W1,400×D600×H370 (mm)
[W55.2×D23.7×H14.6 (in)]
Solid Wood Top

maple	No.3E04-26	No.3E04-66		
ash	No.3E05-36	No.3E05-86		
oak	No.3E52-26	No.3E52-F6	No.3E52-86	No.3E52-K6
	No.3E06-26	No.3E06-36	No.3E06-86	
walnut	No.3E07-66	No.3E07-26		



TRAY TABLE 57 (oval)
W570×D300×H200 (mm)
[W22.5×D11.9×H7.9 (in)]
Solid Wood Top

maple	No.3E38-22	No.3E38-62		
ash	No.3E39-32	No.3E39-82		
oak	No.3E53-22	No.3E53-F2	No.3E53-82	No.3E53-K2
	No.3E40-22	No.3E40-32	No.3E40-82	
walnut	No.3E41-62	No.3E41-22		

Table	maple	 clear (C-0)	 matte clay white (EN-0)			
	ash	 whitish (NL-0)	 natural black (NK-1)			
	oak	 bold clear (BC-0)	 bold whitish (NQ-0)	 bold black (BNK-1)	 bold charcoal (NU-0)	
		 clear (C-0)	 whitish (NL-0)	 natural black (NK-1)		
walnut	 clear (C-0)	 light brown (WB-1)				

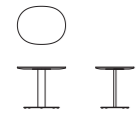

SIDE TABLE 53 (oval)
W530×D420×H450 (mm)
[W20.9×D16.6×H17.8 (in)]
Solid Wood Top
Steel Base

maple	No.3E08-26	No.3E08-66		
ash	No.3E09-36	No.3E09-86		
oak	No.3E54-26	No.3E54-F6	No.3E54-86	No.3E54-K6
	No.3E10-26	No.3E10-36	No.3E10-86	
walnut	No.3E11-66	No.3E11-26		

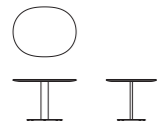





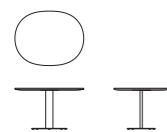







SIDE TABLE 70 (oval)
W695×D550×H450 (mm)
[W27.4×D21.7×H17.8 (in)]
Solid Wood Top
Steel Base

maple	No.3E12-26	No.3E12-66		
ash	No.3E13-36	No.3E13-86		
oak	No.3E55-26	No.3E55-F6	No.3E55-86	No.3E55-K6
	No.3E14-26	No.3E14-36	No.3E14-86	
walnut	No.3E15-66	No.3E15-26		



SIDE TABLE 76 (oval)
W760×D600×H450 (mm)
[W30.0×D23.7×H17.8 (in)]
Solid Wood Top
Steel Base

maple	No.3E16-26	No.3E16-66		
ash	No.3E17-36	No.3E17-86		
oak	No.3E56-26	No.3E56-F6	No.3E56-86	No.3E56-K6
	No.3E18-26	No.3E18-36	No.3E18-86	
walnut	No.3E19-66	No.3E19-26		

Table	maple	 clear (C-0)	 matte clay white (EN-0)			
	ash	 whitish (NL-0)	 natural black (NK-1)			
	oak	 bold clear (BC-0)	 bold whitish (NQ-0)	 bold black (BNK-1)	 bold charcoal (NU-0)	
		 clear (C-0)	 whitish (NL-0)	 natural black (NK-1)		
walnut	 clear (C-0)	 light brown (WB-1)				

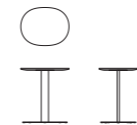

LOBBY TABLE 53 (oval)
W530×D420×H600 (mm)
[W20.9×D16.6×H23.7 (in)]
Solid Wood Top
Steel Base

maple	No.3E20-26	No.3E20-66		
ash	No.3E21-36	No.3E21-86		
oak	No.3E57-26	No.3E57-F6	No.3E57-86	No.3E57-K6
	No.3E22-26	No.3E22-36	No.3E22-86	
walnut	No.3E23-66	No.3E23-26		

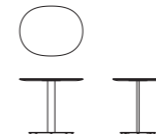

LOBBY TABLE 70 (oval)
W695×D550×H600 (mm)
[W27.4×D21.7×H23.7 (in)]
Solid Wood Top
Steel Base



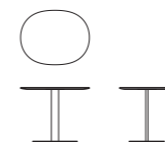









maple	No.3E24-26	No.3E24-66		
ash	No.3E25-36	No.3E25-86		
oak	No.3E58-26	No.3E58-F6	No.3E58-86	No.3E58-K6
	No.3E26-26	No.3E26-36	No.3E26-86	
walnut	No.3E27-66	No.3E27-26		



LOBBY TABLE 76 (oval)
W760×D600×H600 (mm)
[W30.0×D23.7×H23.7 (in)]
Solid Wood Top
Steel Base

maple	No.3E28-26	No.3E28-66		
ash	No.3E29-36	No.3E29-86		
oak	No.3E59-26	No.3E59-F6	No.3E59-86	No.3E59-K6
	No.3E30-26	No.3E30-36	No.3E30-86	
walnut	No.3E31-66	No.3E31-26		

Table

maple	 clear (C-0)	 matte clay white (EN-0)		
ash	 whitish (NL-0)	 natural black (NK-1)		
oak	 bold clear (BC-0)	 bold whitish (NQ-0)	 bold black (BNK-1)	 bold charcoal (NU-0)
	 clear (C-0)	 whitish (NL-0)	 natural black (NK-1)	
walnut	 clear (C-0)	 light brown (WB-1)		

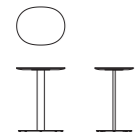

TABLE 53 (oval)
W530×D420×H700 (mm)
[W20.9×D16.6×H27.6 (in)]
Solid Wood Top
Steel Base

maple	No.1E19-26	No.1E19-66		
ash	No.1E20-36	No.1E20-86		
oak	No.1E97-26	No.1E97-F6	No.1E97-86	No.1E97-K6
	No.1E21-26	No.1E21-36	No.1E21-86	
walnut	No.1E22-66	No.1E22-26		

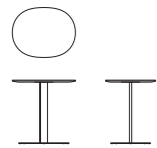

TABLE 70 (oval)
W695×D550×H700 (mm)
[W27.4×D21.7×H27.6 (in)]
Solid Wood Top
Steel Base

maple	No.1E23-26	No.1E23-66		
ash	No.1E24-36	No.1E24-86		
oak	No.1E98-26	No.1E98-F6	No.1E98-86	No.1E98-K6
	No.1E25-26	No.1E25-36	No.1E25-86	
walnut	No.1E26-66	No.1E26-26		

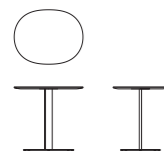













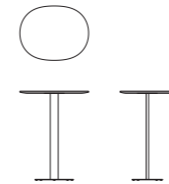

TABLE 76 (oval)
W760×D600×H700 (mm)
[W30.0×D23.7×H27.6 (in)]
Solid Wood Top
Steel Base

maple	No.1E27-26	No.1E27-66		
ash	No.1E28-36	No.1E28-86		
oak	No.1E99-26	No.1E99-F6	No.1E99-86	No.1E99-K6
	No.1E29-26	No.1E29-36	No.1E29-86	
walnut	No.1E30-66	No.1E30-26		

Table

maple	 clear (C-0)	 matte clay white (EN-0)		
ash	 whitish (NL-0)	 natural black (NK-1)		
oak	 bold clear (BC-0)	 bold whitish (NQ-0)	 bold black (BNK-1)	 bold charcoal (NU-0)
	 clear (C-0)	 whitish (NL-0)	 natural black (NK-1)	
walnut	 clear (C-0)	 light brown (WB-1)		



BAR TABLE 70 Mid (oval)
W695×D550×H900 (mm)
[W27.4×D21.7×H35.5 (in)]
Solid Wood Top
Steel Base

maple	No.1E48-26	No.1E48-66		
ash	No.1E49-36	No.1E49-86		
oak	No.1F00-26	No.1F00-F6	No.1F00-86	No.1F00-K6
	No.1E50-26	No.1E50-36	No.1E50-86	
walnut	No.1E51-66	No.1E51-26		

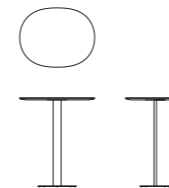

BAR TABLE 76 Mid (oval)
W760×D600×H900 (mm)
[W30.0×D23.7×H35.5 (in)]
Solid Wood Top
Steel Base

maple	No.1E52-26	No.1E52-66		
ash	No.1E53-36	No.1E53-86		
oak	No.1F01-26	No.1F01-F6	No.1F01-86	No.1F01-K6
	No.1E54-26	No.1E54-36	No.1E54-86	
walnut	No.1E55-66	No.1E55-26		

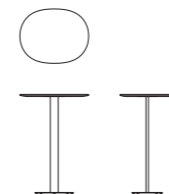

BAR TABLE 70 High (oval)
W695×D550×H1,000 (mm)
[W24.7×D21.7×H39.4 (in)]
Solid Wood Top
Steel Base

maple	No.1E56-26	No.1E56-66		
ash	No.1E57-36	No.1E57-86		
oak	No.1F02-26	No.1F02-F6	No.1F02-86	No.1F02-K6
	No.1E58-26	No.1E58-36	No.1E58-86	
walnut	No.1E59-66	No.1E59-26		

maple

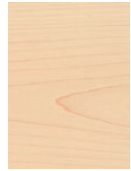

urethane finish, clear (C-0)

urethane finish, matte clay white (EN-0)

ash

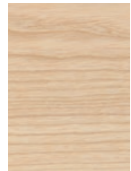

urethane finish, whitish (NL-0)

urethane finish, natural black (NK-1)

oak

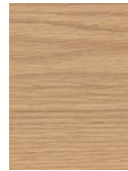
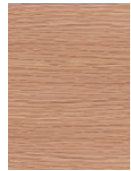

urethane finish, bold clear (BC-0)

urethane finish, bold whitish (NQ-0)

urethane finish, bold black (BNK-1)

urethane finish, bold charcoal (NU-0)

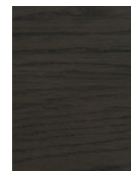
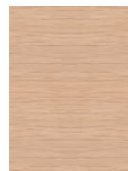

urethane finish, clear (C-0)

urethane finish, whitish (NL-0)

urethane finish, natural black (NK-1)

walnut

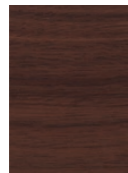
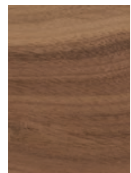

urethane finish, clear (C-0)

urethane finish, light brown (WB-1)

steel



matte clay white powder coated

Sofa

ash		whitish (NL-0)
		bold whitish (NQ-0)
oak		clear (C-0)
		whitish (NL-0)

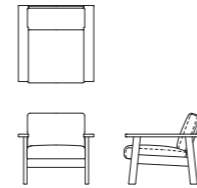

ARM SOFA
W830×D850×H780×SH420 (mm)
[W32.7×D33.5×H30.8×SH16.6 (in)]

ash	No.4517-31	
oak	No.4E60-F1	
	No.4506-21	No.4506-31

cushion cover for ARM SOFA No.4506-91

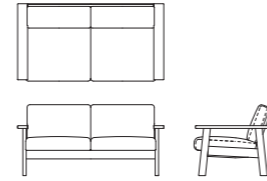

TWO SEATER SOFA
W1,610×D850×H780×SH420 (mm)
[W63.4×D33.5×H30.8×SH16.6 (in)]

ash	No.4517-32	
oak	No.4E60-F2	
	No.4506-22	No.4506-32

cushion cover for TWO SEATER SOFA No.4506-92

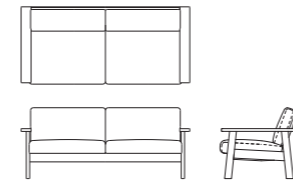

WIDE TWO SEATER SOFA
W1,860×D850×H780×SH420 (mm)
[W73.3×D33.5×H30.8×SH16.6 (in)]

ash	No.4517-34	
oak	No.4E60-F4	
	No.4506-24	No.4506-34

cushion cover for WIDE TWO SEATER SOFA No.4506-94

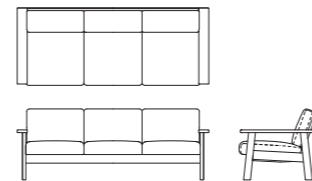

THREE SEATER SOFA
W2,110×D850×H780×SH420 (mm)
[W83.1×D33.5×H30.8×SH16.6 (in)]

ash	No.4517-33	
oak	No.4E60-F3	
	No.4506-23	No.4506-33

cushion cover for THREE SEATER SOFA No.4506-93

Table

ash		whitish (NL-0)
oak		bold whitish (NQ-0)
		clear (C-0)
		whitish (NL-0)

ash	No.3547-31	
oak	No.3E60-F1	
	No.3536-21	No.3536-31
ash	No.3547-32	
oak	No.3E60-F2	
	No.3536-22	No.3536-32

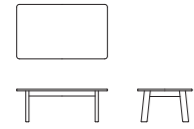

COFFEE TABLE 100
W1,000×D600×H360 (mm)
[W39.4×D23.7×H14.2 (in)]
Veneered Top

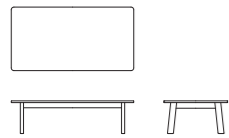

COFFEE TABLE 135
W1,350×D700×H360 (mm)
[W53.2×D27.6×H14.2 (in)]
Veneered Top

ash

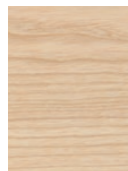

urethane finish,
whitish
(NL-0)



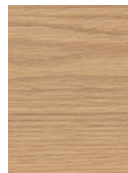



















































































oak



urethane finish,
bold whitish
(NQ-0)









urethane finish, clear (C-0) urethane finish, whitish (NL-0)

M-01	TWILL											
M-02	Remix											
	SAGA											
	MAYA											
	Livorno											
M-03	BAROJA											
	Merit											
M-04	Melange Nap											
	Quay											
M-05	Divina MD											
	Tonus											
M-06	Hallingdal											
L-01	leather	*1										
	tanned leather	not available										
L-02	elmosoft	*1										

*1 Leather is not available for WIDE TWO SEATER SOFA, nor any cushion covers.

ASIAN BENCH

NAOTO FUKASAWA

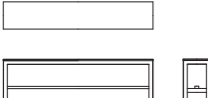
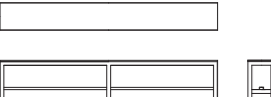
Stool • Bench		oak			
					
					
	STOOL W300×D200×H440 (mm) [W11.9×D7.9×H17.4 (in)]	oak	No.2F55-F5	No.2F55-95	
			No.2017-25	No.2017-35	No.2017-95
	BENCH 165 W1,650×D300×H440 (mm) [W65.0×D11.9×H17.4 (in)]	oak	No.2F56-F4	No.2F56-94	
			No.2014-24	No.2014-34	No.2014-94
	BENCH 240 W2,400×D300×H440 (mm) [W94.5×D11.9×H17.4 (in)]	oak	No.2F56-F8	No.2F56-98	
			No.2014-28	No.2014-38	No.2014-98

oak

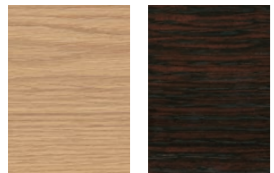

urethane finish, bold whitish (NQ-0) urethane finish, bold rose brown (BMR-1)

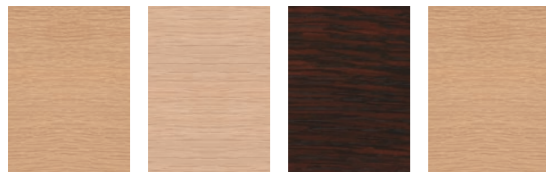

urethane finish, clear (C-0) urethane finish, whitish (NL-0) urethane finish, rose brown (MR-1) oil finish, clear (NB-1)

Botan

JASPER MORRISON

Bench		oak			
					
					
	BENCH 122 W1,220×D517×H726×SH414 (mm) [W48.1×D20.4×H28.6×SH16.3 (in)]	oak	No.4E61-F2	No.4E61-82	No.4E61-K2
			No.4107-32	No.4107-82	
	BENCH 210 W2,100×D517×H726×SH414 (mm) [W82.7×D20.4×H28.6×SH16.3 (in)]	oak	No.4E61-F7	No.4E61-87	No.4E61-K7
			No.4107-37	No.4107-87	
	BENCH 122 Basic W1,220×D396×H414 (mm) [W48.1×D15.6×H16.3 (in)]	oak	No.4E62-F2	No.4E62-82	No.4E62-K2
			No.4257-32	No.4257-82	
	BENCH 210 Basic W2,100×D396×H414 (mm) [W82.7×D15.6×H16.3 (in)]	oak	No.4E62-F7	No.4E62-87	No.4E62-K7
			No.4257-37	No.4257-87	

oak



urethane finish, bold whitish (NQ-0) urethane finish, bold black (BNK-1) urethane finish, bold charcoal (NU-0)

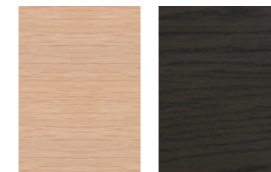

urethane finish, whitish (NL-0) urethane finish, natural black (NK-1)

Table [wood leg]











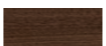

		oak		walnut	
					
					
	<p>TABLE 180 Low (rectangular) W1,800×D900×H700 intercrural width: 1,180 (mm) [W70.9×D35.5×H27.6 intercrural width: 46.5 (in)] Solid Wood Top</p>	oak	No.1E63-9F-1870		
		walnut	No.1987-92-1870	No.1987-93-1870	
	<p>TABLE 180 High (rectangular) W1,800×D900×H720 intercrural width: 1,180 (mm) [W70.9×D35.5×H28.4 intercrural width: 46.5 (in)] Solid Wood Top</p>	oak	No.1E63-9F-1872		
		walnut	No.1987-92-1872	No.1987-93-1872	
	<p>TABLE 190 Low (rectangular) W1,900×D900×H700 intercrural width: 1,250 (mm) [W74.9×D35.5×H27.6 intercrural width: 49.3 (in)] Solid Wood Top</p>	oak	No.1E63-9F-1970		
		walnut	No.1987-92-1970	No.1987-93-1970	
	<p>TABLE 190 High (rectangular) W1,900×D900×H720 intercrural width: 1,250 (mm) [W74.9×D35.5×H28.4 intercrural width: 49.3 (in)] Solid Wood Top</p>	oak	No.1E63-9F-1972		
		walnut	No.1987-92-1972	No.1987-93-1972	
	<p>TABLE 200 Low (rectangular) W2,000×D900×H700 intercrural width: 1,350 (mm) [W78.8×D35.5×H27.6 intercrural width: 53.2 (in)] Solid Wood Top</p>	oak	No.1E63-9F-2070		
		walnut	No.1987-92-2070	No.1987-93-2070	
	<p>TABLE 200 High (rectangular) W2,000×D900×H720 intercrural width: 1,350 (mm) [W78.8×D35.5×H28.4 intercrural width: 53.2 (in)] Solid Wood Top</p>	oak	No.1E63-9F-2072		
		walnut	No.1987-92-2072	No.1987-93-2072	
	<p>TABLE 210 Low (rectangular) W2,100×D900×H700 intercrural width: 1,450 (mm) [W82.7×D35.5×H27.6 intercrural width: 57.1 (in)] Solid Wood Top</p>	oak	No.1E63-9F-2170		
		walnut	No.1987-92-2170	No.1987-93-2170	
	<p>TABLE 210 High (rectangular) W2,100×D900×H720 intercrural width: 1,450 (mm) [W82.7×D35.5×H28.4 intercrural width: 57.1 (in)] Solid Wood Top</p>	oak	No.1E63-9F-2172		
		walnut	No.1987-92-2172	No.1987-93-2172	

Table [wood leg]

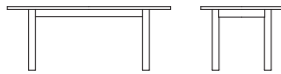

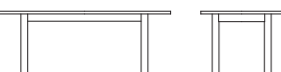

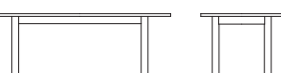

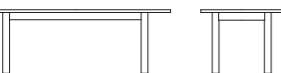



		oak		walnut	
					
					
	<p>TABLE 220 Low (rectangular) W2,200×D900×H700 intercrural width: 1,550 (mm) [W86.7×D35.5×H27.6 intercrural width: 61.1 (in)] Solid Wood Top</p>	oak	No.1E63-9F-2270		
		walnut	No.1987-92-2270	No.1987-93-2270	
	<p>TABLE 220 High (rectangular) W2,200×D900×H720 intercrural width: 1,550 (mm) [W86.7×D35.5×H28.4 intercrural width: 61.1 (in)] Solid Wood Top</p>	oak	No.1E63-9F-2272		
		walnut	No.1987-92-2272	No.1987-93-2272	
	<p>TABLE 230 Low (rectangular) W2,300×D900×H700 intercrural width: 1,650 (mm) [W90.6×D35.5×H27.6 intercrural width: 65.0 (in)] Solid Wood Top</p>	oak	No.1E63-9F-2370		
		walnut	No.1987-92-2370	No.1987-93-2370	
	<p>TABLE 230 High (rectangular) W2,300×D900×H720 intercrural width: 1,650 (mm) [W90.6×D35.5×H28.4 intercrural width: 65.0 (in)] Solid Wood Top</p>	oak	No.1E63-9F-2372		
		walnut	No.1987-92-2372	No.1987-93-2372	
	<p>TABLE 240 Low (rectangular) W2,400×D900×H700 intercrural width: 1,750 (mm) [W94.5×D35.5×H27.6 intercrural width: 68.9 (in)] Solid Wood Top</p>	oak	No.1E63-9F-2470		
		walnut	No.1987-92-2470	No.1987-93-2470	
	<p>TABLE 240 High (rectangular) W2,400×D900×H720 intercrural width: 1,750 (mm) [W94.5×D35.5×H28.4 intercrural width: 68.9 (in)] Solid Wood Top</p>	oak	No.1E63-9F-2472		
		walnut	No.1987-92-2472	No.1987-93-2472	

Table [wood leg]

oak		
		
walnut		

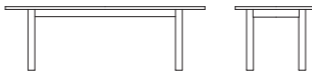
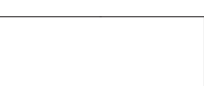
oak	No.1E64-9F-1870	
	No.1997-92-1870	No.1997-93-1870
walnut	No.1998-96-1870	No.1998-92-1870

oak	No.1E64-9F-1872	
	No.1997-92-1872	No.1997-93-1872
walnut	No.1998-96-1872	No.1998-92-1872

oak	No.1E64-9F-1970	
	No.1997-92-1970	No.1997-93-1970
walnut	No.1998-96-1970	No.1998-92-1970

oak	No.1E64-9F-1972	
	No.1997-92-1972	No.1997-93-1972
walnut	No.1998-96-1972	No.1998-92-1972

oak	No.1E64-9F-2070	
	No.1997-92-2070	No.1997-93-2070
walnut	No.1998-96-2070	No.1998-92-2070

oak	No.1E64-9F-2072	
	No.1997-92-2072	No.1997-93-2072
walnut	No.1998-96-2072	No.1998-92-2072

oak	No.1E64-9F-2170	
	No.1997-92-2170	No.1997-93-2170
walnut	No.1998-96-2170	No.1998-92-2170

oak	No.1E64-9F-2172	
	No.1997-92-2172	No.1997-93-2172
walnut	No.1998-96-2172	No.1998-92-2172

TABLE 180 Low (rectangular)

W1,800×D1,050×H700 intercrural width: 1,180 (mm)
[W70.9×D41.4×H27.6 intercrural width: 46.5 (in)]
Solid Wood Top

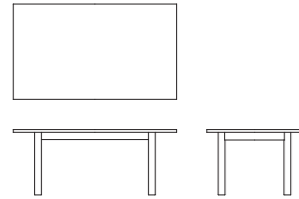

TABLE 180 High (rectangular)

W1,800×D1,050×H720 intercrural width: 1,180 (mm)
[W70.9×D41.4×H28.4 intercrural width: 46.5 (in)]
Solid Wood Top

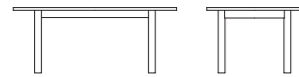

TABLE 190 Low (rectangular)

W1,900×D1,050×H700 intercrural width: 1,250 (mm)
[W74.9×D41.4×H27.6 intercrural width: 49.3 (in)]
Solid Wood Top

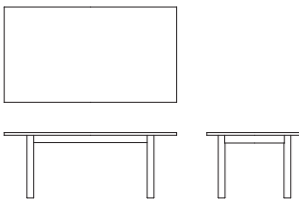

TABLE 190 High (rectangular)

W1,900×D1,050×H720 intercrural width: 1,250 (mm)
[W74.9×D41.4×H28.4 intercrural width: 49.3 (in)]
Solid Wood Top

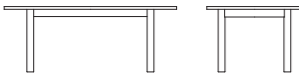

TABLE 200 Low (rectangular)

W2,000×D1,050×H700 intercrural width: 1,350 (mm)
[W78.8×D41.4×H27.6 intercrural width: 53.2 (in)]
Solid Wood Top

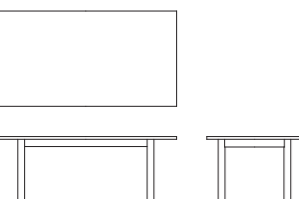

TABLE 200 High (rectangular)

W2,000×D1,050×H720 intercrural width: 1,350 (mm)
[W78.8×D41.4×H28.4 intercrural width: 53.2 (in)]
Solid Wood Top

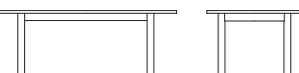

TABLE 210 Low (rectangular)

W2,100×D1,050×H700 intercrural width: 1,450 (mm)
[W82.7×D41.4×H27.6 intercrural width: 57.1 (in)]
Solid Wood Top

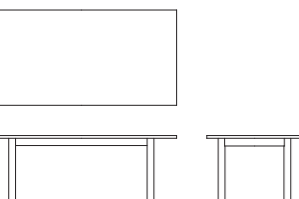

TABLE 210 High (rectangular)

W2,100×D1,050×H720 intercrural width: 1,450 (mm)
[W82.7×D41.4×H28.4 intercrural width: 57.1 (in)]
Solid Wood Top

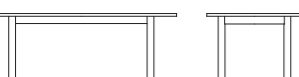

Table [wood leg]

oak		
		
walnut		

oak	No.1E64-9F-2270	
	No.1997-92-2270	No.1997-93-2270
walnut	No.1998-96-2270	No.1998-92-2270

oak	No.1E64-9F-2272	
	No.1997-92-2272	No.1997-93-2272
walnut	No.1998-96-2272	No.1998-92-2272

oak	No.1E64-9F-2370	
	No.1997-92-2370	No.1997-93-2370
walnut	No.1998-96-2370	No.1998-92-2370

oak	No.1E64-9F-2372	
	No.1997-92-2372	No.1997-93-2372
walnut	No.1998-96-2372	No.1998-92-2372

oak	No.1E64-9F-2470	
	No.1997-92-2470	No.1997-93-2470
walnut	No.1998-96-2470	No.1998-92-2470

oak	No.1E64-9F-2472	
	No.1997-92-2472	No.1997-93-2472
walnut	No.1998-96-2472	No.1998-92-2472

TABLE 220 Low (rectangular)

W2,200×D1,050×H700 intercrural width: 1,550 (mm)
[W86.7×D41.4×H27.6 intercrural width: 61.1 (in)]
Solid Wood Top

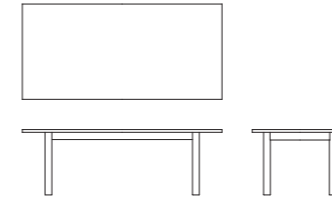

TABLE 220 High (rectangular)

W2,200×D1,050×H720 intercrural width: 1,550 (mm)
[W86.7×D41.4×H28.4 intercrural width: 61.1 (in)]
Solid Wood Top

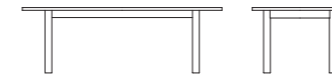

TABLE 230 Low (rectangular)

W2,300×D1,050×H700 intercrural width: 1,650 (mm)
[W90.6×D41.4×H27.6 intercrural width: 65.0 (in)]
Solid Wood Top

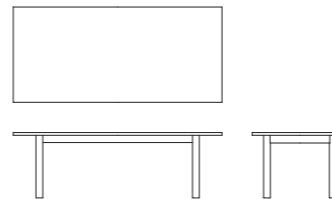

TABLE 230 High (rectangular)

W2,300×D1,050×H720 intercrural width: 1,650 (mm)
[W90.6×D41.4×H28.4 intercrural width: 65.0 (in)]
Solid Wood Top

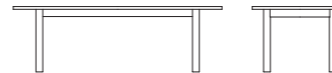

TABLE 240 Low (rectangular)

W2,400×D1,050×H700 intercrural width: 1,750 (mm)
[W94.5×D41.4×H27.6 intercrural width: 68.9 (in)]
Solid Wood Top

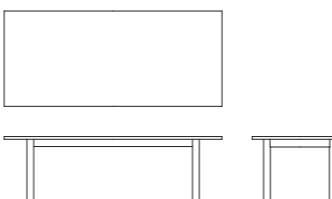

TABLE 240 High (rectangular)

W2,400×D1,050×H720 intercrural width: 1,750 (mm)
[W94.5×D41.4×H28.4 intercrural width: 68.9 (in)]
Solid Wood Top



Table [steel leg]

oak			
	bold whitish (NQ-0)		
oak			
	clear (C-0)	whitish (NL-0)	clear (NB-1/Oil)
walnut			
	clear (C-0)	light brown (WB-1)	

TABLE 180 Low (rectangular)
W1,800×D850×H700
intercrural width: 1,346 (mm)
[W70.9×D33.5×H27.6
intercrural width: 53.0 (in)]
Solid Wood Top

oak	No.1E65-9F -1870		
	No.1887-92 -1870	No.1887-93 -1870	No.1887-94 -1870
walnut	No.1888-96 -1870	No.1888-92 -1870	

TABLE 180 High (rectangular)
W1,800×D850×H720
intercrural width: 1,346 (mm)
[W70.9×D33.5×H28.4
intercrural width: 53.0 (in)]
Solid Wood Top

oak	No.1E65-9F -1872		
	No.1887-92 -1872	No.1887-93 -1872	No.1887-94 -1872
walnut	No.1888-96 -1872	No.1888-92 -1872	

TABLE 180 Extra High (rectangular)
W1,800×D850×H750
intercrural width: 1,346 (mm)
[W70.9×D33.5×H29.6
intercrural width: 53.0 (in)]
Solid Wood Top

oak	No.1E65-9F -1875		
	No.1887-92 -1875	No.1887-93 -1875	No.1887-94 -1875
walnut	No.1888-96 -1875	No.1888-92 -1875	

TABLE 200 Low (rectangular)
W2,000×D900×H700
intercrural width: 1,346 (mm)
[W78.8×D35.5×H27.6
intercrural width: 53.0 (in)]
Solid Wood Top

oak	No.1E65-9F -2070		
	No.1887-92 -2070	No.1887-93 -2070	No.1887-94 -2070
walnut	No.1888-96 -2070	No.1888-92 -2070	

TABLE 200 High (rectangular)
W2,000×D900×H720
intercrural width: 1,346 (mm)
[W78.8×D35.5×H28.4
intercrural width: 53.0 (in)]
Solid Wood Top

oak	No.1E65-9F -2072		
	No.1887-92 -2072	No.1887-93 -2072	No.1887-94 -2072
walnut	No.1888-96 -2072	No.1888-92 -2072	

TABLE 200 Extra High (rectangular)
W2,000×D900×H750
intercrural width: 1,346 (mm)
[W78.8×D35.5×H29.6
intercrural width: 53.0 (in)]
Solid Wood Top

oak	No.1E65-9F -2075		
	No.1887-92 -2075	No.1887-93 -2075	No.1887-94 -2075
walnut	No.1888-96 -2075	No.1888-92 -2075	

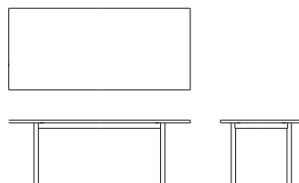
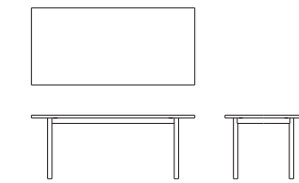

Table [steel leg]

oak			
	bold whitish (NQ-0)		
oak			
	clear (C-0)	whitish (NL-0)	clear (NB-1/Oil)
walnut			
	clear (C-0)	light brown (WB-1)	

TABLE 220 Low (rectangular)
W2,200×D950×H700
intercrural width: 1,786 (mm)
[W86.7×D37.5×H27.6
intercrural width: 70.4 (in)]
Solid Wood Top

oak	No.1E65-9F -2270		
	No.1887-92 -2270	No.1887-93 -2270	No.1887-94 -2270
walnut	No.1888-96 -2270	No.1888-92 -2270	

TABLE 220 High (rectangular)
W2,200×D950×H720
intercrural width: 1,786 (mm)
[W86.7×D37.5×H28.4
intercrural width: 70.4 (in)]
Solid Wood Top

oak	No.1E65-9F -2272		
	No.1887-92 -2272	No.1887-93 -2272	No.1887-94 -2272
walnut	No.1888-96 -2272	No.1888-92 -2272	

TABLE 220 Extra High (rectangular)
W2,200×D950×H750
intercrural width: 1,786 (mm)
[W86.7×D37.5×H29.6
intercrural width: 70.4 (in)]
Solid Wood Top

oak	No.1E65-9F -2275		
	No.1887-92 -2275	No.1887-93 -2275	No.1887-94 -2275
walnut	No.1888-96 -2275	No.1888-92 -2275	

TABLE 240 Low (rectangular)
W2,400×D1,050×H700
intercrural width: 1,786 (mm)
[W94.5×D41.4×H27.6
intercrural width: 70.4 (in)]
Solid Wood Top

oak	No.1E65-9F -2470		
	No.1887-92 -2470	No.1887-93 -2470	No.1887-94 -2470
walnut	No.1888-96 -2470	No.1888-92 -2470	

TABLE 240 High (rectangular)
W2,400×D1,050×H720
intercrural width: 1,786 (mm)
[W94.5×D41.4×H28.4
intercrural width: 70.4 (in)]
Solid Wood Top

oak	No.1E65-9F -2472		
	No.1887-92 -2472	No.1887-93 -2472	No.1887-94 -2472
walnut	No.1888-96 -2472	No.1888-92 -2472	

TABLE 240 Extra High (rectangular)
W2,400×D1,050×H750
intercrural width: 1,786 (mm)
[W94.5×D41.4×H29.6
intercrural width: 70.4 (in)]
Solid Wood Top

oak	No.1E65-9F -2475		
	No.1887-92 -2475	No.1887-93 -2475	No.1887-94 -2475
walnut	No.1888-96 -2475	No.1888-92 -2475	

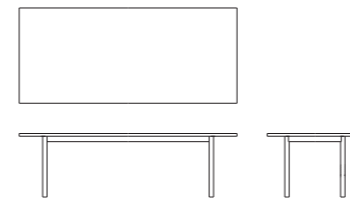

Table [steel leg]

oak			
	bold whitish (NQ-0)		
oak			
	clear (C-0)	whitish (NL-0)	clear (NB-1/Oil)
walnut			
	clear (C-0)	light brown (WB-1)	

TABLE 320 Low (rectangular)
W3,200×D1,150×H700
intercrural width : 2,321 (mm)
[W126.0×D45.3×H27.6
intercrural width : 91.4 (in)]
Solid Wood Top

oak	No.1E65-9F-3270		
	No.1887-92-3270	No.1887-93-3270	No.1887-94-3270
walnut	No.1888-96-3270	No.1888-92-3270	

TABLE 320 High (rectangular)
W3,200×D1,150×H720
intercrural width : 2,321 (mm)
[W126.0×D45.3×H28.4
intercrural width : 91.4 (in)]
Solid Wood Top

oak	No.1E65-9F-3272		
	No.1887-92-3272	No.1887-93-3272	No.1887-94-3272
walnut	No.1888-96-3272	No.1888-92-3272	

TABLE 320 Extra High (rectangular)
W3,200×D1,150×H750
intercrural width : 2,321 (mm)
[W126.0×D45.3×H29.6
intercrural width : 91.4 (in)]
Solid Wood Top

oak	No.1E65-9F-3275		
	No.1887-92-3275	No.1887-93-3275	No.1887-94-3275
walnut	No.1888-96-3275	No.1888-92-3275	

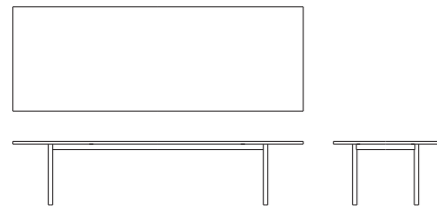

oak



urethane finish,
bold whitish
(NQ-0)



urethane finish,
clear
(C-0) urethane finish,
whitish
(NL-0) oil finish,
clear
(NB-1)

walnut

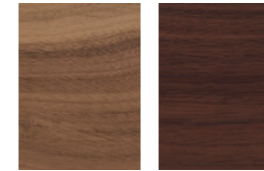

urethane finish,
clear
(C-0) urethane finish,
light brown
(WB-1)

steel



black
synthetic resin
coated

Table

oak		
		
walnut		

TABLE 180 Low (rectangular)
W1,800×D875×H700 intercrural width: 1,350 (mm)
[W70.9×D34.5×H27.6 intercrural width: 53.2 (in)]
Solid Wood Top

oak	No.1F03-F5	
	No.1E04-25	No.1E04-35
walnut	No.1E05-65	No.1E05-25

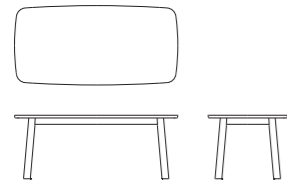

TABLE 180 High (rectangular)
W1,800×D875×H720 intercrural width: 1,350 (mm)
[W70.9×D34.5×H28.4 intercrural width: 53.2 (in)]
Solid Wood Top

oak	No.1F03-F5 -0072	
	No.1E04-25 -0072	No.1E04-35 -0072
walnut	No.1E05-65 -0072	No.1E05-25 -0072

TABLE 180 Extra High (rectangular)
W1,800×D875×H750 intercrural width: 1,350 (mm)
[W70.9×D34.5×H29.6 intercrural width: 53.2 (in)]
Solid Wood Top

oak	No.1F03-F5 -0075	
	No.1E04-25 -0075	No.1E04-35 -0075
walnut	No.1E05-65 -0075	No.1E05-25 -0075

TABLE 200 Low (rectangular)
W2,000×D930×H700 intercrural width: 1,550 (mm)
[W78.8×D36.7×H27.6 intercrural width: 61.1 (in)]
Solid Wood Top

oak	No.1F03-F6	
	No.1E04-26	No.1E04-36
walnut	No.1E05-66	No.1E05-26

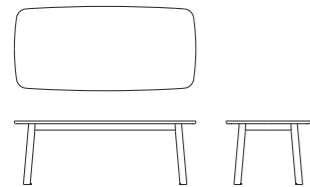

TABLE 200 High (rectangular)
W2,000×D930×H720 intercrural width: 1,550 (mm)
[W78.8×D36.7×H28.4 intercrural width: 61.1 (in)]
Solid Wood Top

oak	No.1F03-F6 -0072	
	No.1E04-26 -0072	No.1E04-36 -0072
walnut	No.1E05-66 -0072	No.1E05-26 -0072

TABLE 200 Extra High (rectangular)
W2,000×D930×H750 intercrural width: 1,550 (mm)
[W78.8×D36.7×H29.6 intercrural width: 61.1 (in)]
Solid Wood Top

oak	No.1F03-F6 -0075	
	No.1E04-26 -0075	No.1E04-36 -0075
walnut	No.1E05-66 -0075	No.1E05-26 -0075

Table

oak		
		
walnut		

TABLE 220 Low (rectangular)
W2,200×D970×H700 intercrural width: 1,710 (mm)
[W86.7×D38.2×H27.6 intercrural width: 67.4 (in)]
Solid Wood Top

oak	No.1F03-F7	
	No.1E04-27	No.1E04-37
walnut	No.1E05-67	No.1E05-27

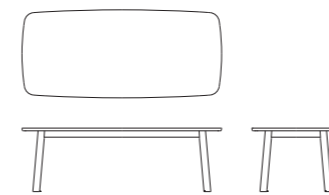

TABLE 220 High (rectangular)
W2,200×D970×H720 intercrural width: 1,710 (mm)
[W86.7×D38.2×H28.4 intercrural width: 67.4 (in)]
Solid Wood Top

oak	No.1F03-F7 -0072	
	No.1E04-27 -0072	No.1E04-37 -0072
walnut	No.1E05-67 -0072	No.1E05-27 -0072

TABLE 220 Extra High (rectangular)
W2,200×D970×H750 intercrural width: 1,710 (mm)
[W86.7×D38.2×H29.6 intercrural width: 67.4 (in)]
Solid Wood Top

oak	No.1F03-F7 -0075	
	No.1E04-27 -0075	No.1E04-37 -0075
walnut	No.1E05-67 -0075	No.1E05-27 -0075

TABLE 240 Low (rectangular)
W2,400×D1,000×H700 intercrural width: 1,860 (mm)
[W94.5×D39.4×H27.6 intercrural width: 73.3 (in)]
Solid Wood Top

oak	No.1F03-F8	
	No.1E04-28	No.1E04-38
walnut	No.1E05-68	No.1E05-28

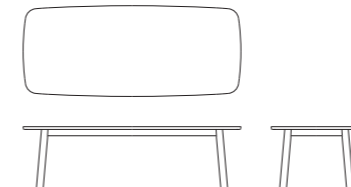

TABLE 240 High (rectangular)
W2,400×D1,000×H720 intercrural width: 1,860 (mm)
[W94.5×D39.4×H28.4 intercrural width: 73.3 (in)]
Solid Wood Top

oak	No.1F03-F8 -0072	
	No.1E04-28 -0072	No.1E04-38 -0072
walnut	No.1E05-68 -0072	No.1E05-28 -0072

TABLE 240 Extra High (rectangular)
W2,400×D1,000×H750 intercrural width: 1,860 (mm)
[W94.5×D39.4×H29.6 intercrural width: 73.3 (in)]
Solid Wood Top

oak	No.1F03-F8 -0075	
	No.1E04-28 -0075	No.1E04-38 -0075
walnut	No.1E05-68 -0075	No.1E05-28 -0075

Table

oak		
	bold whitish (NQ-0)	
walnut		
	clear (C-0)	whitish (NL-0)
walnut		
	clear (C-0)	light brown (WB-1)

TABLE 320 Low (rectangular)
W3,200×D1,200×H700 intercrural width : 2,560 (mm)
[W126.0×D47.3×H27.6 intercrural width : 100.8 (in)]
Solid Wood Top

TABLE 320 High (rectangular)
W3,200×D1,200×H720 intercrural width : 2,560 (mm)
[W126.0×D47.3×H28.4 intercrural width : 100.8 (in)]
Solid Wood Top

TABLE 320 Extra High (rectangular)
W3,200×D1,200×H750 intercrural width : 2,560 (mm)
[W126.0×D47.3×H29.6 intercrural width : 100.8 (in)]
Solid Wood Top

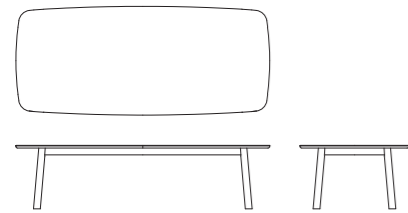

oak	No.1F03-F9	
	No.1E04-29	No.1E04-39
walnut	No.1E05-69	No.1E05-29
oak	No.1F03-F9-0072	
	No.1E04-29-0072	No.1E04-39-0072
walnut	No.1E05-69-0072	No.1E05-29-0072
oak	No.1F03-F9-0075	
	No.1E04-29-0075	No.1E04-39-0075
walnut	No.1E05-69-0075	No.1E05-29-0075

Table (ceramic top)

ceramic (top)				
oak (leg)				
	bold whitish (NQ-0)	bold whitish (NQ-0)		
walnut (leg)				
	clear (C-0)	whitish (NL-0)	clear (C-0)	whitish (NL-0)
				
	clear (C-0)	light brown (WB-1)	clear (C-0)	light brown (WB-1)

TABLE 180 Low (rectangular)
W1,800×D875×H700 intercrural width : 1,350 (mm)
[W70.9×D34.5×H27.6 intercrural width : 53.2 (in)]
Ceramic Top

TABLE 180 High (rectangular)
W1,800×D875×H720 intercrural width : 1,350 (mm)
[W70.9×D34.5×H28.4 intercrural width : 53.2 (in)]
Ceramic Top

TABLE 180 Extra High (rectangular)
W1,800×D875×H750 intercrural width : 1,350 (mm)
[W70.9×D34.5×H29.6 intercrural width : 53.2 (in)]
Ceramic Top

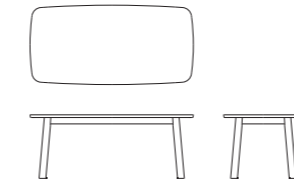

oak	No.1F04-F5		No.1F05-F5	
	No.1E15-25	No.1E15-35	No.1E16-25	No.1E16-35
walnut	No.1E17-65	No.1E17-25	No.1E18-65	No.1E18-25
oak	No.1F04-F5-0072		No.1F05-F5-0072	
	No.1E15-25-0072	No.1E15-35-0072	No.1E16-25-0072	No.1E16-35-0072
walnut	No.1E17-65-0072	No.1E17-25-0072	No.1E18-65-0072	No.1E18-25-0072
oak	No.1F04-F5-0075		No.1F05-F5-0075	
	No.1E15-25-0075	No.1E15-35-0075	No.1E16-25-0075	No.1E16-35-0075
walnut	No.1E17-65-0075	No.1E17-25-0075	No.1E18-65-0075	No.1E18-25-0075
oak	No.1F04-F6		No.1F05-F6	
	No.1E15-26	No.1E15-36	No.1E16-26	No.1E16-36
walnut	No.1E17-66	No.1E17-26	No.1E18-66	No.1E18-26
oak	No.1F04-F6-0072		No.1F05-F6-0072	
	No.1E15-26-0072	No.1E15-36-0072	No.1E16-26-0072	No.1E16-36-0072
walnut	No.1E17-66-0072	No.1E17-26-0072	No.1E18-66-0072	No.1E18-26-0072
oak	No.1F04-F6-0075		No.1F05-F6-0075	
	No.1E15-26-0075	No.1E15-36-0075	No.1E16-26-0075	No.1E16-36-0075
walnut	No.1E17-66-0075	No.1E17-26-0075	No.1E18-66-0075	No.1E18-26-0075

TABLE 200 Low (rectangular)
W2,000×D930×H700 intercrural width : 1,550 (mm)
[W78.8×D36.7×H27.6 intercrural width : 61.1 (in)]
Ceramic top

TABLE 200 High (rectangular)
W2,000×D930×H720 intercrural width : 1,550 (mm)
[W78.8×D36.7×H28.4 intercrural width : 61.1 (in)]
Ceramic Top

TABLE 200 Extra High (rectangular)
W2,000×D930×H750 intercrural width : 1,550 (mm)
[W78.8×D36.7×H29.6 intercrural width : 61.1 (in)]
Ceramic Top



Table (ceramic top)

ceramic (top)	CALACATTA		DARK MARQUINA	
oak (leg)	bold whitish (NQ-0)		bold whitish (NQ-0)	
walnut (leg)				
	clear (C-0)	whitish (NL-0)	clear (C-0)	whitish (NL-0)
	clear (C-0)	light brown (WB-1)	clear (C-0)	light brown (WB-1)

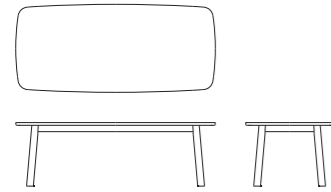

TABLE 220 Low (rectangular)
W2,200×D970×H700
intercrural width: 1,710 (mm)
[W86.7×D38.2×H27.6
intercrural width: 67.4 (in)]
Ceramic Top

oak

No.1F04-F7

No.1F05-F7

No.1E15-27 No.1E15-37 No.1E16-27 No.1E16-37

walnut

No.1E17-67 No.1E17-27 No.1E18-67 No.1E18-27

TABLE 220 High (rectangular)
W2,200×D970×H720
intercrural width: 1,710 (mm)
[W86.7×D38.2×H28.4
intercrural width: 67.4 (in)]
Ceramic Top

oak

No.1F04-F7
-0072

No.1F05-F7
-0072

No.1E15-27
-0072 No.1E15-37
-0072 No.1E16-27
-0072 No.1E16-37
-0072

walnut

No.1E17-67
-0072 No.1E17-27
-0072 No.1E18-67
-0072 No.1E18-27
-0072

TABLE 220 Extra High (rectangular)
W2,200×D970×H750
intercrural width: 1,710 (mm)
[W86.7×D38.2×H29.6
intercrural width: 67.4 (in)]
Ceramic Top

oak

No.1F04-F7
-0075

No.1F05-F7
-0075

No.1E15-27
-0075 No.1E15-37
-0075 No.1E16-27
-0075 No.1E16-37
-0075

walnut

No.1E17-67
-0075 No.1E17-27
-0075 No.1E18-67
-0075 No.1E18-27
-0075

TABLE 240 Low (rectangular)
W2,400×D1,000×H700
intercrural width: 1,860 (mm)
[W94.5×D39.4×H27.6
intercrural width: 73.3 (in)]
Ceramic Top

oak

No.1F04-F8

No.1F05-F8

No.1E15-28 No.1E15-38 No.1E16-28 No.1E16-38

walnut

No.1E17-68 No.1E17-28 No.1E18-68 No.1E18-28

TABLE 240 High (rectangular)
W2,400×D1,000×H720
intercrural width: 1,860 (mm)
[W94.5×D39.4×H28.4
intercrural width: 73.3 (in)]
Ceramic Top

oak

No.1F04-F8
-0072

No.1F05-F8
-0072

No.1E15-28
-0072 No.1E15-38
-0072 No.1E16-28
-0072 No.1E16-38
-0072

walnut

No.1E17-68
-0072 No.1E17-28
-0072 No.1E18-68
-0072 No.1E18-28
-0072

TABLE 240 Extra High (rectangular)
W2,400×D1,000×H750
intercrural width: 1,860 (mm)
[W94.5×D39.4×H29.6
intercrural width: 73.3 (in)]
Ceramic Top

oak

No.1F04-F8
-0075

No.1F05-F8
-0075

No.1E15-28
-0075 No.1E15-38
-0075 No.1E16-28
-0075 No.1E16-38
-0075

walnut

No.1E17-68
-0075 No.1E17-28
-0075 No.1E18-68
-0075 No.1E18-28
-0075

Table (ceramic top)

ceramic (top)	CALACATTA		DARK MARQUINA	
oak (leg)	bold whitish (NQ-0)		bold whitish (NQ-0)	
walnut (leg)				
	clear (C-0)	whitish (NL-0)	clear (C-0)	whitish (NL-0)
	clear (C-0)	light brown (WB-1)	clear (C-0)	light brown (WB-1)

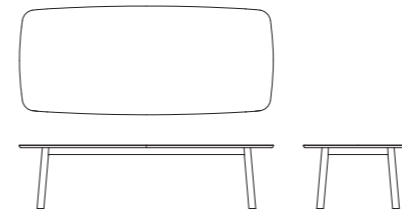

TABLE 280 Low (rectangular)
W2,800×D1,200×H700
intercrural width: 2,160 (mm)
[W110.3×D47.3×H27.6
intercrural width: 85.1 (in)]
Ceramic Top

oak

No.1F04-F9

No.1F05-F9

No.1E15-29 No.1E15-39 No.1E16-29 No.1E16-39

walnut

No.1E17-69 No.1E17-29 No.1E18-69 No.1E18-29

TABLE 280 High (rectangular)
W2,800×D1,200×H720
intercrural width: 2,160 (mm)
[W110.3×D47.3×H28.4
intercrural width: 85.1 (in)]
Ceramic Top

oak

No.1F04-F9
-0072

No.1F05-F9
-0072

No.1E15-29
-0072 No.1E15-39
-0072 No.1E16-29
-0072 No.1E16-39
-0072

walnut

No.1E17-69
-0072 No.1E17-29
-0072 No.1E18-69
-0072 No.1E18-29
-0072

TABLE 280 Extra High (rectangular)
W2,800×D1,200×H750
intercrural width: 2,160 (mm)
[W110.3×D47.3×H29.6
intercrural width: 85.1 (in)]
Ceramic Top

oak

No.1F04-F9
-0075

No.1F05-F9
-0075

No.1E15-29
-0075 No.1E15-39
-0075 No.1E16-29
-0075 No.1E16-39
-0075

walnut

No.1E17-69
-0075 No.1E17-29
-0075 No.1E18-69
-0075 No.1E18-29
-0075

ceramic



CALACATTA

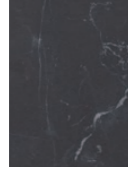

DARK MARQUINA

oak

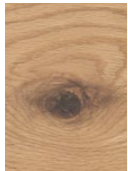

urethane finish,
bold whitish
(NQ-0)



urethane finish,
clear
(C-0)



urethane finish,
whitish
(NL-0)

walnut



urethane finish,
clear
(C-0)

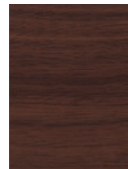

urethane finish,
light brown
(WB-1)

fabric M-01: TWILL chemical recycled polyester 24% polyester 76% (JAPAN)

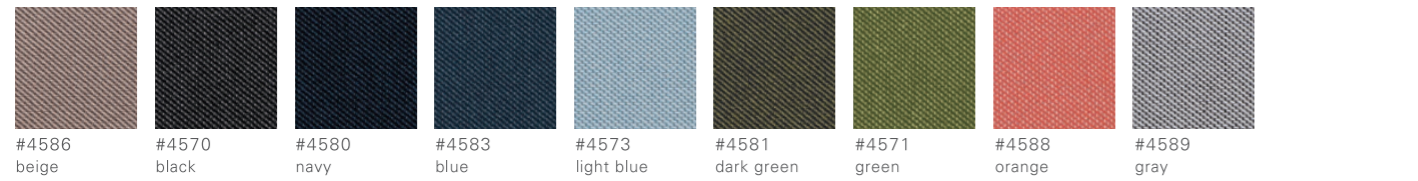

fabric M-02: Remix wool 90% nylon 10% (DENMARK)



fabric M-02: SAGA cotton 20% polyester 80% (TURKEY)

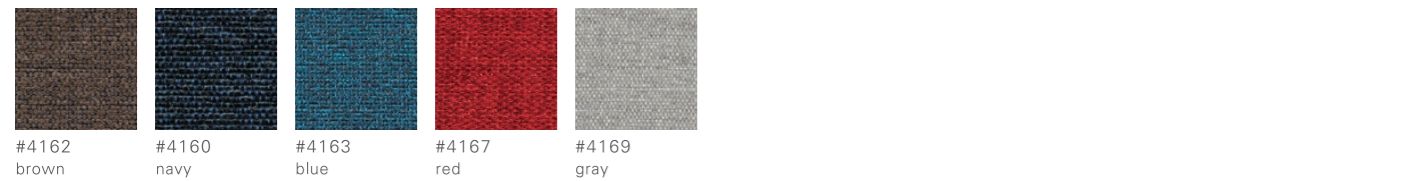

fabric M-02: MAYA polyester 100% (ITALY)

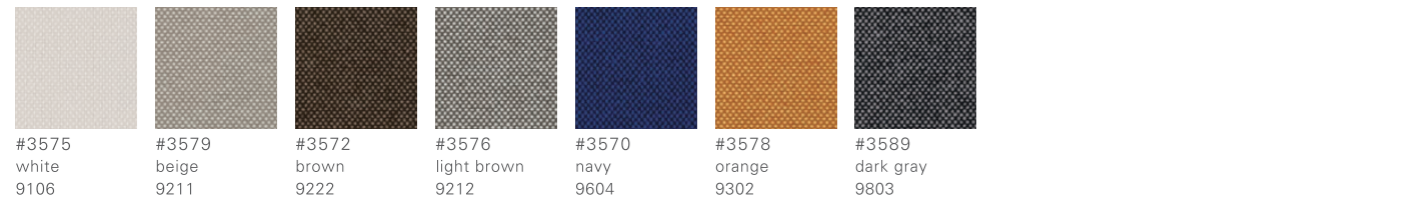

fabric M-02: Livorno cotton 10% polyester 90% (SPAIN)

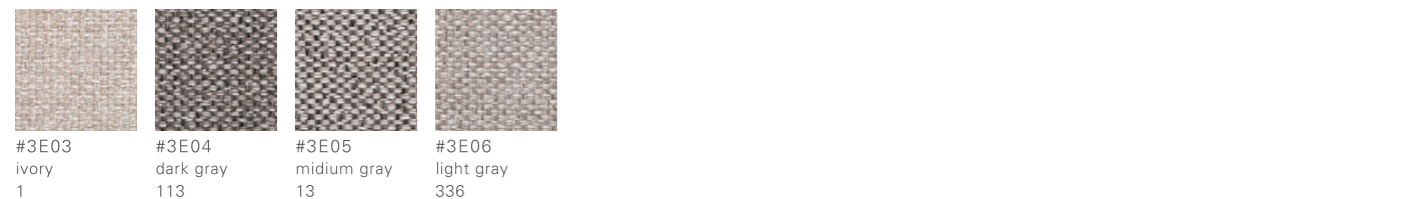

fabric M-03: BAROJA polyester 100% (SPAIN)



fabric M-03: Merit post-consumer recycled polyester 76% Polyester 24% (UNITED STATES)



fabric M-04: Melange Nap wool 97% nylon 3% (DENMARK)



fabric M-04: Quay post-industrial recycled cotton 66% rayon 6% polyester 27% nylon 1% (UNITED STATES)



fabric M-05: Divina MD wool 100% (DENMARK)



fabric M-06: Tonus wool 90% nylon 10% (DENMARK)



fabric M-06: Hallingdal rayon 30% wool 70% (DENMARK)



leather L-01: leather tanned leather (JAPAN)



leather L-02: elmosoft (SWEDEN)

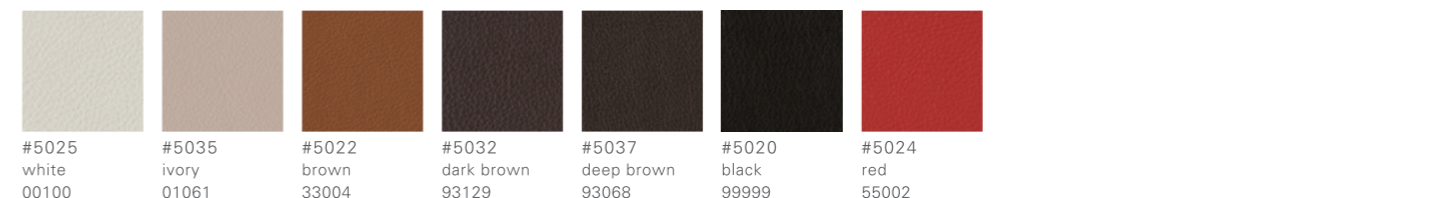







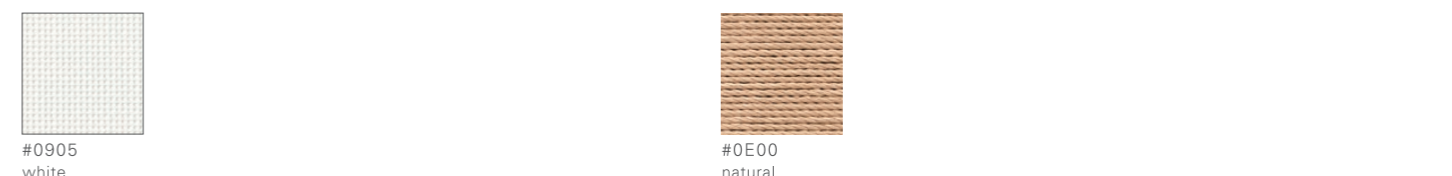



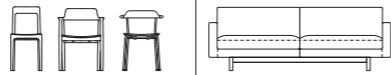

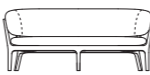



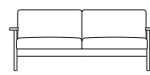



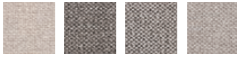

webbing nylon 100% (JAPAN)



mesh PVC covered polyester mesh (JAPAN) paper cord paper 100% (JAPAN)



Fabric List

PRODUCT		HIROSHIMA	Roundish	Roundish	Tako	MEGURO	Lightwood	EN	Bruno
									
M-01 TWILL		●	●	●	●	●	●	▲*4	●
M-02 Remix		●	●	●	●	●	●	▲*4	●
SAGA		●	●	●	●	●	●		●
MAYA		●	●	●	●	●	●	▲*4	●
Livorno		●	●	●	●	●	●		
M-03 BAROJA		▲*1	●	●	●	●	●		
Merit		●	●		●	●	●	▲*4	●
M-04 Melange Nap		●	●	●	●	●	●	▲*4	●
Quay		●	●	●	●	●	●	▲*4	●
M-05 Divina MD		●	●	●	●	●	●	▲*4	●
Tonus		●	●	●	●	●	●	▲*4	●
M-06 Hallingdal		●	●	●	●	●	●	▲*4	●
L-01 leather		●	▲*2	▲*3	●	●	●	▲*4	▲*5
tanned leather		●	▲*2	▲*3	●	●	●	▲*4	
L-02 elmosoft		●	▲*2	▲*3	●	●	●	▲*4	▲*5
webbing							●		
mesh • paper cord							●		

▲ - available only on select products. *1 - not applicable for ARMCHAIR STACKABLE. *2 - applicable only for BOLSTER CUSHION.

*3 - not applicable for ARMCHAIR. *4 - only specified fabric is available for CHAIR (cushioned). *5 - not applicable for WIDE TWO SEATER SOFA.

Attention

Our products are made from natural wood that may cause the color & grain pattern to slightly differ for one by one. Images on this brochure may appear differently than the actual product due to printing conditions. Dimensions are approximate and may slightly differ from actual products. Design / specification are subject to change without notice due to product modification. Dimensions are in millimeters and in inches. The products shown are items as of April 2026.
© MARUNI WOOD INDUSTRY INC. All rights reserved.

maruni
MARUNI WOOD INDUSTRY INC.

24 Shirasago Yuki-cho Saeki-ku
Hiroshima-shi Hiroshima, 738 - 0512 Japan

contact@maruni.com
www.maruni.com

2026 04006 G

maruni